



DIGITAL PIANO
PIANO NUMERIQUE
PIANO DIGITAL

P-515

Owner's Manual
Mode d'emploi
Manual de instrucciones

English

Français

Español

Thank you for purchasing this Yamaha Digital Piano!

This instrument provides exceptionally high-quality sound and expressive control for your playing enjoyment. We recommend that you read this manual carefully so that you can fully take advantage of the advanced and convenient functions of the instrument.

We also recommend that you keep this manual in a safe and handy place for future reference.

Before using the instrument, be sure to read "PRECAUTIONS" on pages 5–6.

Merci d'avoir acheté ce Piano numérique de Yamaha !

Cet instrument offre une qualité de son et une expressivité exceptionnelles pour votre plus grand plaisir.

Nous vous conseillons de lire attentivement ce mode d'emploi afin de tirer pleinement profit des fonctions avancées et très pratiques de votre instrument.

Nous vous recommandons également de garder ce manuel à portée de main pour toute référence ultérieure.

Avant d'utiliser l'instrument, lisez attentivement la section « PRÉCAUTIONS D'USAGE » aux pages 5 et 6.

Le damos las gracias por adquirir este Piano Digital Yamaha.

Este instrumento ofrece un sonido de alta calidad y un control expresivo excepcionales para que disfrute tocando. Le aconsejamos que lea detenidamente este manual para poder disfrutar de las útiles y avanzadas funciones del instrumento.

Recomendamos guardar el manual en un lugar seguro y accesible, para futuras consultas.

Antes de utilizar el instrumento, lea las "PRECAUCIONES", en las páginas 5-6.



EN

FR

ES

SPECIAL MESSAGE SECTION

This product utilizes batteries or an external power supply (adapter). DO NOT connect this product to any power supply or adapter other than one described in the manual, on the name plate, or specifically recommended by Yamaha.

WARNING: Do not place this product in a position where anyone could walk on, trip over, or roll anything over power or connecting cords of any kind. The use of an extension cord is not recommended! If you must use an extension cord, the minimum wire size for a 25' cord (or less) is 18 AWG. NOTE: The smaller the AWG number, the larger the current handling capacity. For longer extension cords, consult a local electrician.

This product should be used only with the components supplied or; a cart, rack, or stand that is recommended by Yamaha. If a cart, etc., is used, please observe all safety markings and instructions that accompany the accessory product.

SPECIFICATIONS SUBJECT TO CHANGE:

The information contained in this manual is believed to be correct at the time of printing. However, Yamaha reserves the right to change or modify any of the specifications without notice or obligation to update existing units.

This product, either alone or in combination with an amplifier and headphones or speaker/s, may be capable of producing sound levels that could cause permanent hearing loss. DO NOT operate for long periods of time at a high volume level or at a level that is uncomfortable. If you experience any hearing loss or ringing in the ears, you should consult an audiologist.

IMPORTANT: The louder the sound, the shorter the time period before damage occurs.

Some Yamaha products may have benches and / or accessory mounting fixtures that are either supplied with the product or as optional accessories. Some of these items are designed to be dealer assembled or installed. Please make sure that benches are stable and any optional fixtures (where applicable) are well secured BEFORE using.

Benches supplied by Yamaha are designed for seating only. No other uses are recommended.

NOTICE:

Service charges incurred due to a lack of knowledge relating to how a function or effect works (when the unit is operating as designed) are not covered by the manufacturer's warranty, and are therefore the owners responsibility. Please study this manual carefully and consult your dealer before requesting service.

ENVIRONMENTAL ISSUES:

Yamaha strives to produce products that are both user safe and environmentally friendly. We sincerely believe that our products and the production methods used to produce them, meet these goals. In keeping with both the letter and the spirit of the law, we want you to be aware of the following:

Battery Notice:

This product MAY contain a small non-rechargeable battery which (if applicable) is soldered in place. The average life span of this type of battery is approximately five years. When replacement becomes necessary, contact a qualified service representative to perform the replacement.

This product may also use "household" type batteries. Some of these may be rechargeable. Make sure that the battery being charged is a rechargeable type and that the charger is intended for the battery being charged.

When installing batteries, never mix old batteries with new ones, and never mix different types of batteries. Batteries MUST be installed correctly. Mismatches or incorrect installation may result in overheating and battery case rupture.

Warning:

Do not attempt to disassemble, or incinerate any battery. Keep all batteries away from children. Dispose of used batteries promptly and as regulated by the laws in your area. Note: Check with any retailer of household type batteries in your area for battery disposal information.

Disposal Notice:

Should this product become damaged beyond repair, or for some reason its useful life is considered to be at an end, please observe all local, state, and federal regulations that relate to the disposal of products that contain lead, batteries, plastics, etc. If your dealer is unable to assist you, please contact Yamaha directly.

NAME PLATE LOCATION:

The name plate is located on the bottom of the product. The model number, serial number, power requirements, etc., are located on this plate. You should record the model number, serial number, and the date of purchase in the spaces provided below and retain this manual as a permanent record of your purchase.

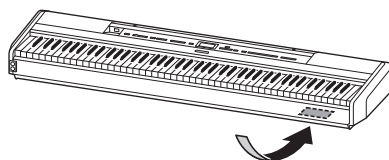

Model

Serial No.

Purchase Date

PLEASE KEEP THIS MANUAL

COMPLIANCE INFORMATION STATEMENT (DECLARATION OF CONFORMITY PROCEDURE)

Responsible Party : Yamaha Corporation of America

Address : 6600 Orangethorpe Ave., Buena Park, Calif. 90620

Telephone : 714-522-9011

Type of Equipment : Digital Piano

Model Name : P-515

This device complies with Part 15 of the FCC Rules.

Operation is subject to the following two conditions:

- 1) this device may not cause harmful interference, and
 - 2) this device must accept any interference received including interference that may cause undesired operation.
- See user manual instructions if interference to radio reception is suspected.

* This applies only to products distributed by Yamaha Corporation of America

(FCC DoC)

For AC adaptor and P-515

FCC INFORMATION (U.S.A.)

1. IMPORTANT NOTICE: DO NOT MODIFY THIS UNIT!

This product, when installed as indicated in the instructions contained in this manual, meets FCC requirements. Modifications not expressly approved by Yamaha may void your authority, granted by the FCC, to use the product.

- 2. IMPORTANT:** When connecting this product to accessories and/or another product use only high quality shielded cables. Cable/s supplied with this product MUST be used. Follow all installation instructions. Failure to follow instructions could void your FCC authorization to use this product in the USA.

- 3. NOTE:** This product has been tested and found to comply with the requirements listed in FCC Regulations, Part 15 for Class "B" digital devices. Compliance with these requirements provides a reasonable level of assurance that your use of this product in a residential environment will not result in harmful interference with other electronic devices. This equipment generates/uses radio frequencies and, if not installed and used according to the instructions found in the users manual, may cause interference harmful to the operation of other electronic devices. Compliance with FCC regulations

does not guarantee that interference will not occur in all installations. If this product is found to be the source of interference, which can be determined by turning the unit "OFF" and "ON", please try to eliminate the problem by using one of the following measures:

Relocate either this product or the device that is being affected by the interference.

Utilize power outlets that are on different branch (circuit breaker or fuse) circuits or install AC line filter/s.

In the case of radio or TV interference, relocate/reorient the antenna. If the antenna lead-in is 300 ohm ribbon lead, change the lead-in to co-axial type cable.

If these corrective measures do not produce satisfactory results, please contact the local retailer authorized to distribute this type of product. If you can not locate the appropriate retailer, please contact Yamaha Corporation of America, Electronic Service Division, 6600 Orangethorpe Ave, Buena Park, CA90620

The above statements apply ONLY to those products distributed by Yamaha Corporation of America or its subsidiaries.

* This applies only to products distributed by YAMAHA CORPORATION OF AMERICA.

(class B)

OBSERVERA!

Apparaten kopplas inte ur växelströmskällan (nätet) så länge som den är ansluten till vägguttaget, även om själva apparaten har stängts av.

ADVARSSEL: Netspændingen til dette apparat er IKKE afbrudt, så længe netledningen sidder i en stikkontakt, som er tændt — også selvom der er slukket på apparatets afbryder.

VAROITUS: Laitteen toisiopiiriin kytketty käyttökytin ei irroita koko laitetta verkosta.

(standby)

This device complies with Part 15 of the FCC Rules. Operation is subject to the following two conditions: (1) this device may not cause harmful interference, and (2) this device must accept any interference received, including interference that may cause undesired operation.

(fcc_sengen)

CAN ICES-3 (B)/NMB-3(B)

(can_b_02)

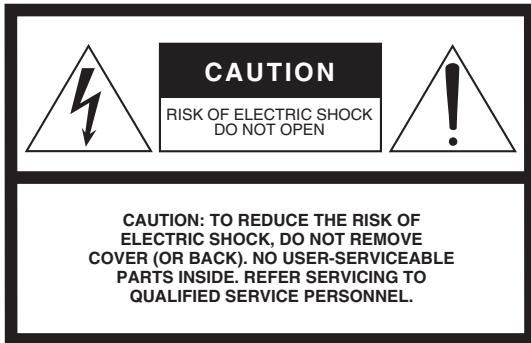

Explanation of Graphical Symbols



The lightning flash with arrowhead symbol within an equilateral triangle is intended to alert the user to the presence of uninsulated “dangerous voltage” within the product’s enclosure that may be of sufficient magnitude to constitute a risk of electric shock to persons.



The exclamation point within an equilateral triangle is intended to alert the user to the presence of important operating and maintenance (servicing) instructions in the literature accompanying the product.

IMPORTANT SAFETY INSTRUCTIONS

- 1 Read these instructions.
- 2 Keep these instructions.
- 3 Heed all warnings.
- 4 Follow all instructions.
- 5 Do not use this apparatus near water.
- 6 Clean only with dry cloth.
- 7 Do not block any ventilation openings. Install in accordance with the manufacturer’s instructions.
- 8 Do not install near any heat sources such as radiators, heat registers, stoves, or other apparatus (including amplifiers) that produce heat.
- 9 Do not defeat the safety purpose of the polarized or grounding-type plug. A polarized plug has two blades with one wider than the other. A grounding type plug has two blades and a third grounding prong. The wide blade or the third prong are provided for your safety. If the provided plug does not fit into your outlet, consult an electrician for replacement of the obsolete outlet.
- 10 Protect the power cord from being walked on or pinched particularly at plugs, convenience receptacles, and the point where they exit from the apparatus.

- 11 Only use attachments/accessories specified by the manufacturer.
- 12 Use only with the cart, stand, tripod, bracket, or table specified by the manufacturer, or sold with the apparatus. When a cart is used, use caution when moving the cart/apparatus combination to avoid injury from tip-over.
- 13 Unplug this apparatus during lightning storms or when unused for long periods of time.
- 14 Refer all servicing to qualified service personnel. Servicing is required when the apparatus has been damaged in any way, such as power-supply cord or plug is damaged, liquid has been spilled or objects have fallen into the apparatus, the apparatus has been exposed to rain or moisture, does not operate normally, or has been dropped.



WARNING

TO REDUCE THE RISK OF FIRE OR ELECTRIC SHOCK, DO NOT EXPOSE THIS APPARATUS TO RAIN OR MOISTURE.

(UL60065_03)

PRECAUTIONS

PLEASE READ CAREFULLY BEFORE PROCEEDING

Please keep this manual in a safe and handy place for future reference.

For AC adaptor



WARNING

- This AC adaptor is designed for use with only Yamaha electronic instruments. Do not use for any other purpose.
- Indoor use only. Do not use in any wet environments.



CAUTION

- When setting up, make sure that the AC outlet is easily accessible. If some trouble or malfunction occurs, immediately turn off the power switch of the instrument and disconnect the AC adaptor from the outlet. When the AC adaptor is connected to the AC outlet, keep in mind that electricity is flowing at the minimum level, even if the power switch is turned off. When you are not using the instrument for a long time, make sure to unplug the power cord from the wall AC outlet.

For P-515



WARNING

Always follow the basic precautions listed below to avoid the possibility of serious injury or even death from electrical shock, short-circuiting, damages, fire or other hazards. These precautions include, but are not limited to, the following:

Power supply/AC adaptor

- Do not place the power cord near heat sources such as heaters or radiators. Also, do not excessively bend or otherwise damage the cord, or place heavy objects on it.
- Only use the voltage specified as correct for the instrument. The required voltage is printed on the name plate of the instrument.
- Use the specified adaptor (page 115) only. Using the wrong adaptor can result in damage to the instrument or overheating.
- Use only the supplied power cord/plug.
- Check the electric plug periodically and remove any dirt or dust which may have accumulated on it.

Do not open

- This instrument contains no user-serviceable parts. Do not open the instrument or attempt to disassemble or modify the internal components in any way. If it should appear to be malfunctioning, discontinue use immediately and have it inspected by qualified Yamaha service personnel.

Location (if Bluetooth functionality is included)

(For information on whether *Bluetooth* functionality is included or not, refer to page 81.)

- Radio waves may affect electro-medical devices.
 - Do not use this product near medical devices or inside areas in which the use of radio waves is restricted.
 - Do not use this product within 15 cm (6 in.) of persons with a heart pacemaker implant.

Water warning

- Do not expose the instrument to rain, use it near water or in damp or wet conditions, or place on it any containers (such as vases, bottles or glasses) containing liquids which might spill into any openings. If any liquid such as water seeps into the instrument, turn off the power immediately and unplug the power cord from the AC outlet. Then have the instrument inspected by qualified Yamaha service personnel.
- Never insert or remove an electric plug with wet hands.

Fire warning

- Do not put burning items, such as candles, on the unit. A burning item may fall over and cause a fire.

If you notice any abnormality

- When one of the following problems occur, immediately turn off the power switch and disconnect the electric plug from the outlet. Then have the device inspected by Yamaha service personnel.
 - The power cord or plug becomes frayed or damaged.
 - It emits unusual smells or smoke.
 - Some object has been dropped into the instrument.
 - There is a sudden loss of sound during use of the instrument.

CAUTION

Always follow the basic precautions listed below to avoid the possibility of physical injury to you or others, or damage to the instrument or other property. These precautions include, but are not limited to, the following:

Power supply/AC adaptor

- Do not connect the instrument to an electrical outlet using a multiple-connector. Doing so can result in lower sound quality, or possibly cause overheating in the outlet.
- When removing the electric plug from the instrument or an outlet, always hold the plug itself and not the cord. Pulling by the cord can damage it.
- Remove the electric plug from the outlet when the instrument is not to be used for extended periods of time, or during electrical storms.

Location

- Do not place the instrument in an unstable position where it might accidentally fall over.
- When transporting or moving the instrument, always use two or more people. Attempting to lift the instrument by yourself may damage your back, result in other injury, or cause damage to the instrument itself.
- Before moving the instrument, remove all connected cables, to prevent damage to the cables or injury to anyone who might trip over them.
- When setting up the product, make sure that the AC outlet you are using is easily accessible. If some trouble or malfunction occurs, immediately turn off the power switch and disconnect the plug from the outlet. Even when the power switch is turned off, electricity is still flowing to the product at the minimum level. When you are not using the product for a long time, make sure to unplug the power cord from the wall AC outlet.
- Use only the stand specified for the instrument. When attaching it, use the provided screws only. Failure to do so could cause damage to the internal components or result in the instrument falling over.

Connections

- Before connecting the instrument to other electronic components, turn off the power for all components. Before turning the power on or off for all components, set all volume levels to minimum.
- Be sure to set the volumes of all components at their minimum levels and gradually raise the volume controls while playing the instrument to set the desired listening level.

Handling caution

- Do not insert a finger or hand in any gaps on the instrument.
- Never insert or drop paper, metallic, or other objects into the gaps on the panel or keyboard. This could cause physical injury to you or others, damage to the instrument or other property, or operational failure.
- Do not rest your weight on, or place heavy objects on the instrument, and do not use excessive force on the buttons, switches or connectors.
- Do not use the instrument/device or headphones for a long period of time at a high or uncomfortable volume level, since this can cause permanent hearing loss. If you experience any hearing loss or ringing in the ears, consult a physician.

Yamaha cannot be held responsible for damage caused by improper use or modifications to the instrument, or data that is lost or destroyed.

Always turn the power off when the instrument is not in use.

Even when the [] (Standby/On) switch is in standby status (power lamp is off), electricity is still flowing to the instrument at the minimum level.

When you are not using the instrument for a long time, make sure you unplug the power cord from the wall AC outlet.

DMI-5 2/2

The model number, serial number, power requirements, etc., may be found on or near the name plate, which is at the bottom of the unit. You should note this serial number in the space provided below and retain this manual as a permanent record of your purchase to aid identification in the event of theft.

Model No.

Serial No.

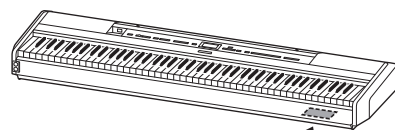

The name plate is located on the bottom of the unit.

(bottom_en_01)

NOTICE

To avoid the possibility of malfunction/ damage to the product, damage to data, or damage to other property, follow the notices below.

■ Handling

- Do not use the instrument in the vicinity of a TV, radio, stereo equipment, mobile phone, or other electric devices. Otherwise, the instrument, TV, or radio may generate noise. When you use the instrument along with an application on your smart device such as iPhone or iPad, etc., we recommend that you set “Airplane Mode” to “ON” on the device and then the Wi-Fi/*Bluetooth* setting to “ON” in order to avoid noise caused by communication.
- Do not expose the instrument to excessive dust or vibrations, or extreme cold or heat (such as in direct sunlight, near a heater, or in a car during the day) to prevent the possibility of panel disfiguration, damage to the internal components or unstable operation. (Verified operating temperature range: 5° – 40°C, or 41° – 104°F.)
- Do not place vinyl, plastic or rubber objects on the instrument, since this might discolor the panel or keyboard.
- Do not lean the instrument against a wall, etc. Doing so may cause damage to the instrument. Make sure to put the instrument horizontally on a table or desk, or use the separately sold keyboard stand (page 115).

■ Maintenance

- When cleaning the instrument, use a soft and dry/slightly damp cloth. Do not use paint thinners, solvents, alcohol, cleaning fluids, or chemical-impregnated wiping cloths.
- During extreme changes in temperature or humidity, condensation may occur and water may collect on the surface of the instrument. If water is left, the wooden parts may absorb the water and be damaged. Make sure to wipe any water off immediately with a soft cloth.

■ Saving data

- Some of the data of this instrument (page 105) are retained when the power is turned off. However, the saved data may be lost due to some failure, an operation mistake, etc. Save your important data onto USB flash drive/an external device such as a computer (page 68). Before using a USB flash drive, make sure to refer to page 74.
- To protect against data loss through USB flash drive damage, we recommend that you save your important data onto spare USB flash drive or an external device such as a computer as backup data.

Information

■ About copyrights

- Copying of the commercially available musical data including but not limited to MIDI data and/or audio data is strictly prohibited except for your personal use.
- This product incorporates and bundles contents in which Yamaha owns copyrights or with respect to which Yamaha has license to use others' copyrights. Due to copyright laws and

other relevant laws, you are NOT allowed to distribute media in which these contents are saved or recorded and remain virtually the same or very similar to those in the product.

*The contents described above include a computer program, Accompaniment Style data, MIDI data, WAVE data, voice recording data, a score, score data, etc.

*You are allowed to distribute medium in which your performance or music production using these contents is recorded, and the permission of Yamaha Corporation is not required in such cases.

■ About functions/data bundled with the instrument

- Some of the preset songs have been edited for length or arrangement, and may not be exactly the same as the original.
- This device is capable of using various types/formats of music data by optimizing them to the proper format music data for use with the device in advance. As a result, this device may not play them back precisely as their producers or composers originally intended.
- The bitmap fonts used in this instrument have been provided by and are the property of Ricoh Co., Ltd.

■ About this manual

- The illustrations and LCD screens as shown in this manual are for instructional purposes only, and may appear somewhat different from those on your instrument.
- The letters at the end of the model name (“B” or “WH”) are color information of the instrument. For example, “B” indicates “black,” and “WH” indicates “white.” Since they simply indicate the color, these letters are omitted in this manual.
- iPhone and iPad are trademarks of Apple Inc., registered in the U.S. and other countries.
- Android™ is a trademark of Google Inc.
- Windows is a registered trademark of Microsoft® Corporation in the United States and other countries.
- IOS is a trademark or registered trademark of Cisco in the U.S. and other countries and is used under license.
-  **Bluetooth®**
The *Bluetooth®* word mark and logos are registered trademarks owned by Bluetooth SIG, Inc. and any use of such marks by Yamaha Corporation is under license.
- The company names and product names in this manual are the trademarks or registered trademarks of their respective companies.

■ Tuning

- Unlike an acoustic piano, this instrument does not need to be tuned by an expert (although the pitch can be user-adjusted to match other instruments). This is because the pitch of digital instruments is always maintained perfectly.

About *Bluetooth*

***Bluetooth* capability**

Depending on the country in which you purchased the product, the instrument may not have *Bluetooth* capability. If the *Bluetooth* logo is printed on the control panel, this means that the product is equipped with *Bluetooth* functionality.

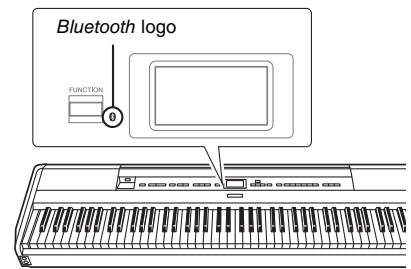

- *Bluetooth* is a technology for wireless communication between devices within an area of about 10 meters (33 ft.) employing the 2.4 GHz frequency band.

■ Handling *Bluetooth* communications

- The 2.4 GHz band used by *Bluetooth* compatible devices is a radio band shared by many types of equipment. While *Bluetooth* compatible devices use a technology minimizing the influence of other components using the same radio band, such influence may reduce the speed or distance of communications and in some cases interrupt communications.
- The speed of signal transfer and the distance at which communication is possible differs according to the distance between the communicating devices, the presence of obstacles, radio wave conditions and the type of equipment.
- Yamaha does not guarantee all wireless connections between this unit and devices compatible with *Bluetooth* function.

Compatible Formats



GM System Level 2

“GM (General MIDI)” is one of the most common Voice allocation formats. “GM System Level 2” is a standard specification that enhances the original “GM” and improves Song data compatibility. It provides for increased polyphony, greater Voice selection, expanded Voice parameters, and integrated effect processing.



XG

XG is a major enhancement of the GM System Level 1 format, and was developed by Yamaha specifically to provide more Voices and variations, as well as greater expressive control over Voices and effects, and to ensure compatibility of data well into the future.



GS

GS was developed by the Roland Corporation. In the same way as Yamaha XG, GS is a major enhancement of the GM specifically to provide more Voices and Drum kits and their variations, as well as greater expressive control over Voices and effects.

Included Accessories

- Owner's Manual (this book) x1
- Online Member Product Registration x1
- Footswitch x1
- Power cord*, AC adaptor x1
- Warranty* x1
 - * May not be included depending on your area. Check with your Yamaha dealer.
- Music Rest x1

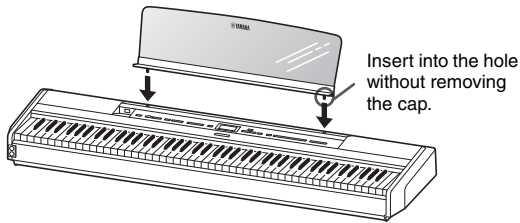

NOTICE

After removing the music rest from the instrument, do not leave it on the instrument for long time. Doing so may cause color transference or glue to adhere to it.

About the Manuals

This instrument has the following documents and instructional materials.

Included Documents



Owner's Manual (this book)

This document explains how to use the instrument.

• Introduction:

This section explains how to set up and start using your instrument. Setup is so simple, you can start playing right away.

• Main Operations:

This section explains various functions useful for your practice, such as Preset Song playback and Song recording.

• Detailed Settings:

This section explains how to make detailed settings for the instrument's various functions. Refer to this section as necessary.

• Appendix:

This section introduces Message List, a description of Preset Voices, and other reference material.

Online Materials (Downloadable from the web)



Smart Device Connection Manual

Explains how to connect the instrument to a smartphone or tablet, etc. You can choose from two versions (for iOS and Android) depending on your device.



Computer-related Operations

Includes instructions on connecting this instrument to a computer, and operations related to transferring song data.



MIDI Reference

Contains the MIDI-related information.



Data List

Contains lists of XG Voices and XG Drum Kit that can be selected on the instrument.

To obtain these manuals, access the Yamaha Downloads, enter the model name for searching desired files.

Yamaha Downloads

<https://download.yamaha.com/>

Smart Device App "Smart Pianist"

Enjoy easy operation by connecting your smart device. "Smart Pianist" app (free for download; page 84) lets you select Voices, make Metronome settings, and even display notation, depending on the selected data.

Features



Authentic portable electric piano, ideal for wide variety of applications

The P-515 portable electric piano provides a remarkably easy way to enjoy authentic piano performance easily. Although packed with various functions, it also exceptionally portable—allowing you use it as a family piano, or practice it in your bedroom, or perform with it at a party. For more permanent installations, use the separately sold keyboard stand (L-515) and pedal unit (LP-1).



Yamaha CFX and Bösendorfer Imperial piano samples

▶▶ page 22

The P-515 features piano sounds created with samples of the Yamaha CFX flagship concert grand piano and famed Vienna-made Bösendorfer* grand piano. These piano samples bring two world's finest and most prominent concert grand pianos to your fingertips.

* Bösendorfer is a subsidiary company of Yamaha.



Virtual Resonance Modeling (VRM) – reproduces the distinctive reverberation of a concert grand piano

▶▶ page 27

This original VRM technology calculated the various states of the strings for each of the 88 notes of the keyboard from one instant to the next, and the timing and depth of the damper pedal presses. The enhanced VRM now also calculates and reproduces aliquot resonance in the upper octaves, and the full resonance of the soundboard, rim, and frame. This technology gives you vivid, bright, richly varied expression, effectively reproducing the complex acoustic interactions when performing on an actual piano.



Natural Wood X (NWX) keyboard – the feel of an acoustic grand piano

The P-515 keyboard features white keys made from select quality wood and fitted with the highest quality synthetic ivory, while the black keys are finished in synthetic ebony. What's more, this keyboard features the characteristic escapement mechanism in a grand piano, which moves the hammers away from the strings quickly after they strike them, in order to prevent any interference with string vibration.



Rhythm Tracks

▶▶ page 43

The P-515 comes complete with forty different and simple rhythm patterns (drums and bass accompaniment) that are perfectly suited to many types of music regularly performed on the piano, for even greater performance potential.



Bluetooth audio function – playing back the audio data wirelessly

▶▶ page 81

The audio data in the smart device such as a *Bluetooth*-equipped smartphone can be played via the P-515 built-in speaker. You can enjoy performing with the audio data, or listen to the music via the P-515 instead of an audio device.

Table of Contents



PRECAUTIONS	5
NOTICE	7
Information	7
About <i>Bluetooth</i> *	8
Compatible Formats	8
Included Accessories	9
About the Manuals	9
Features	10

Introduction 12

Panel Controls and Terminals	12
Getting Started — Playing the Keyboard	14
Turning the Power On or Off	14
Setting the Volume — [MASTER VOLUME]	16
Using Headphones	16
Using a Pedal (Footswitch)	18
Using the Pedal Unit (sold separately)	19
Basic Operations on Display	20

Main Operations 22

Playing Various Musical Instrument Sounds	
(Voices)	22
Selecting Voices	22
Listening to the Voice Demos	24
Customizing the Sound and the Touch Response of	
Piano Voices (Piano Room)	25
Enhancing and Customizing the Sound	28
Playing Two Voices Simultaneously (Dual)	29
Splitting the Keyboard Range and Playing Two	
Different Voices (Split Mode)	30
Using Dual and Split Simultaneously	31
Playing Duo	32
Transposing the Pitch in Semitones (Transpose)	34
Fine Tuning the Pitch (Master Tune)	35
Changing the Touch Sensitivity (Touch)	36
Boosting the Overall Sound (SOUND BOOST)	37
Adjusting the Sound (Master EQ)	38
Locking the Front Panel	40
Using the Metronome	41
Playing the Keyboard along with Rhythm Playback ...	43
Playing Back Songs	44
Playback of Songs	45
Playing a One-hand Part — Part Cancel Function	
(MIDI Songs)	48
Playing Back a Song Repeatedly	49
Adjusting the Volume Balance	52
Useful Playback Functions	53
Recording Your Performance	54
Recording Methods	54
Quick MIDI Recording	55
MIDI Recording — Independent Tracks	57
MIDI Recording to the USB Flash Drive	59

Audio Recording to the USB Flash Drive	61
Other Recording Techniques	62
Handling Song Files	66
Song Types and File Operation Limitations	66
Basic Song File Operation	67
Deleting Files — Delete	68
Copying Files — Copy	68
Moving Files — Move	69
Converting a MIDI Song to an Audio Song	
during Playback — MIDI to Audio	70
Renaming Files — Rename	71
Connections	72
Connectors	72
Connecting USB Devices ([]) (USB TO DEVICE)	
Terminal)	74
Connecting to a Computer/Smart Device ([USB TO	
HOST] Terminal, []) (USB TO DEVICE)	
Terminal, MIDI Terminals)	75
Connecting External MIDI Devices (MIDI Terminals)	80
Effective Use of a Computer or Smart Device	
with the Instrument	81
Listening to Audio Data from a Smart Device through	
this Instrument (<i>Bluetooth</i> Audio Function)	81
Using a Smart Device App	84
Transmitting/Receiving Audio Data	
(USB Audio Interface function)	85
Performing Live	86
Detailed Settings 88	
Basic Operations	88
Voice Menu	89
Song Menu	93
Metronome/Rhythm Menu	96
Recording Menu	97
System Menu	98
Appendix 107	
Preset Voice List	107
Song List	109
50 Classics	109
Rhythm List	109
Message List	110
Troubleshooting	112
Specifications	114
Index	116

*For information on whether *Bluetooth* functionality is included or not, refer to page 8.

Panel Controls and Terminals

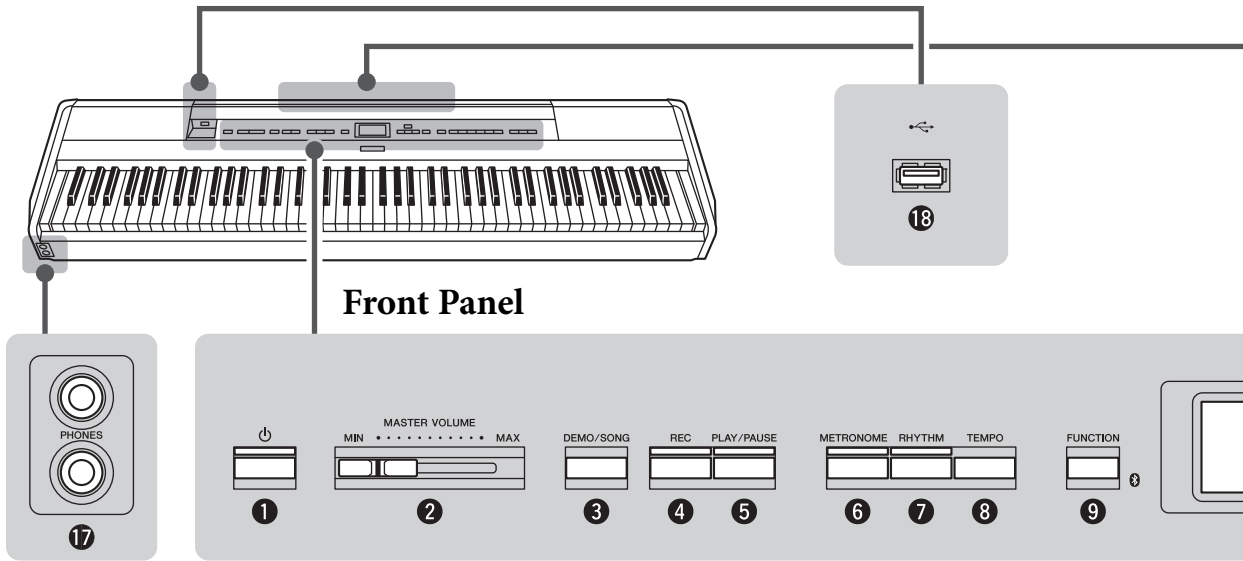

Front Panel

- ❶ [⏻] (Standby/On) switch page 14
For turning the power on or setting it to standby.
- ❷ [MASTER VOLUME] slider page 16
For adjusting the overall volume.
- ❸ [DEMO/SONG] button..... page 24, 44
Calls up Song List folders for selecting Songs for playback, etc.
- ❹ [REC] button page 54
For recording your keyboard performance.
- ❺ [PLAY/PAUSE] button page 45
For alternately playing back and pausing the Preset Songs or your recorded material.
- ❻ [METRONOME] button page 41
For using the metronome functions.
- ❼ [RHYTHM] button page 43
For using the rhythm functions.
- ❽ [TEMPO] button..... page 41
For setting the tempo.
- ❾ [FUNCTION] button..... page 88
Pressing this button alternates the displays among “Voice” menu, “Song” menu, “Metronome/Rhythm” menu, “Recording” menu and “System” menu, from which you can make detailed settings for the related functions.
- ❿ (Bluetooth logo) page 81
If the instrument is equipped with *Bluetooth* functionality, this logo is printed on the front panel. Depending on the country in which you purchased the product, the instrument may not have *Bluetooth* capability.
- ⓫ [^]/[v]/[<]/[>] buttons, display page 20
For selecting an item or setting a value using the buttons corresponding to the display indication.
- ⓬ [EXIT] button page 21
Pressing this button exits from the current display, or returns to the Voice or Song display.
- ⓭ [PIANO ROOM] button..... page 25
Calls up the Piano Room display where you can select an optimum piano sound and adjust the touch response.

Rear Panel

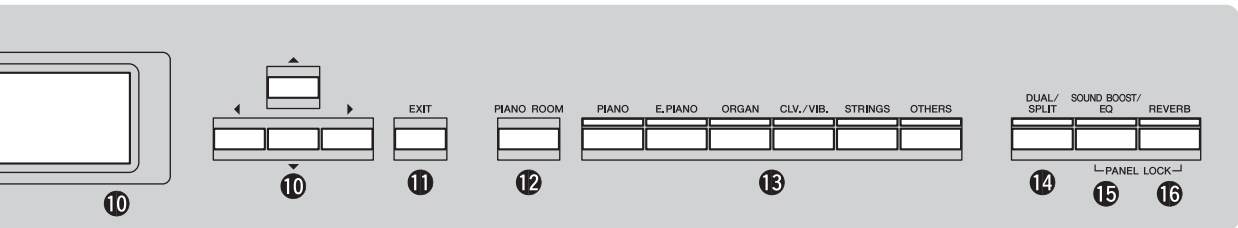
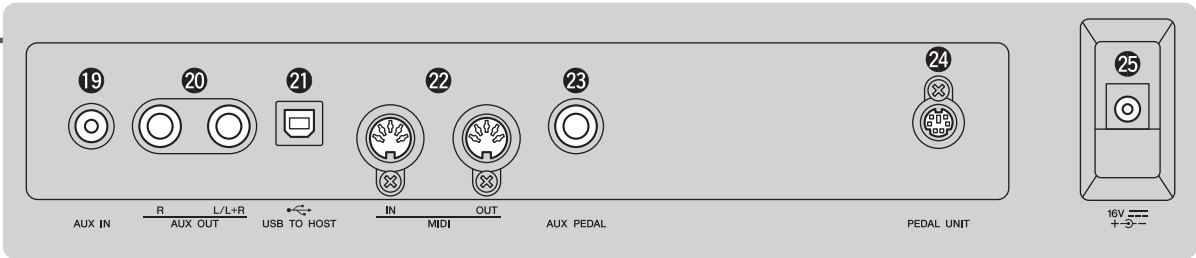

- 13** **Voice button** page 22
Selects the Voice (keyboard sound).
- 14** **[DUAL/SPLIT] button**page 29, 30, 31
For playing two Voices simultaneously, or different Voices on the left- and right-hand sections of the keyboard.
- 15** **[SOUND BOOST/EQ] button** page 38, 37
Calls up the Sound Boost or Master EQ display. These allow you to raise the volume and enhance the presence of your performance (Sound Boost), or adjust the tone of the sound (Master EQ).
- 16** **[REVERB] button** page 28
Calls up the Reverb display, for adding and changing reverberation in the sound.
- 17** **[PHONES] jacks**..... page 16
For connecting a pair of headphones.
- 18** **[] (USB TO DEVICE) terminal**
.....page 72, 74, 75
For connecting a USB flash drive or a smart device, such as an iPhone/iPad.

Rear Panel

- 19** **[AUX IN] jack**..... page 72
For connecting headphone jack of a portable audio player, etc.
- 20** **AUX OUT [R]/[L/L+R] jacks**..... page 73
For connecting to external powered speaker systems, etc.
- 21** **[USB TO HOST] terminal**.....page 73, 75
For connecting a computer or a smart device, such as an iPhone/iPad.
- 22** **MIDI [IN] [OUT] terminals**.....page 73, 80
For connecting external MIDI devices, such as a synthesizer or a sequencer.
- 23** **[AUX PEDAL] jack**page 18, 73
For connecting an included foot pedal, or separately sold foot pedal or foot switch.
- 24** **[PEDAL UNIT] terminal**..... page 19
Connecting a separately sold pedal unit.
- 25** **DC IN jack** page 14
For connecting the included AC adaptor.

Getting Started — Playing the Keyboard

This section explains how to set up and start using your instrument. Setup is so simple, you can start playing right away.

Turning the Power On or Off

1. Connect the power cord and AC adaptor.

Connect the plugs of the AC adaptor in the order shown in the illustration.

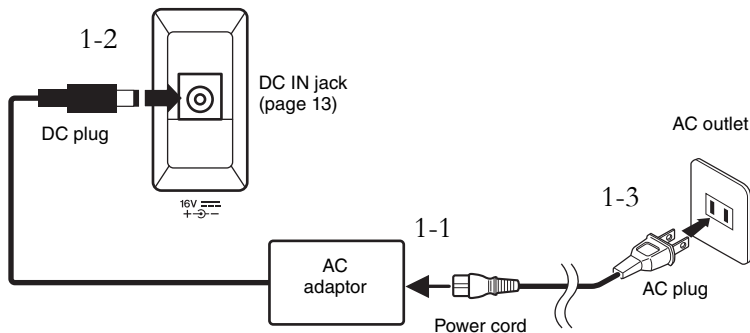

2. Turn down the [MASTER VOLUME] slider at the right end of the front panel to “MIN.”

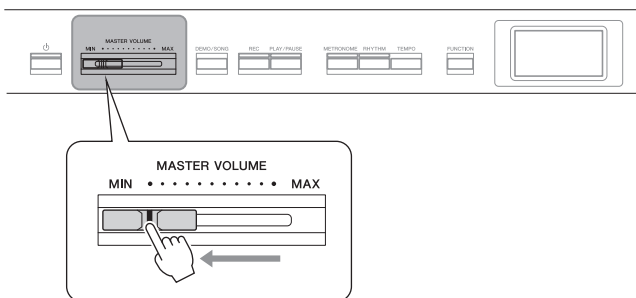

3. Press the [⏻] (Standby/On) switch to turn the power on.

The [⏻] (Standby/On) switch lights up and the Voice display appears on the display at the center of the front panel.

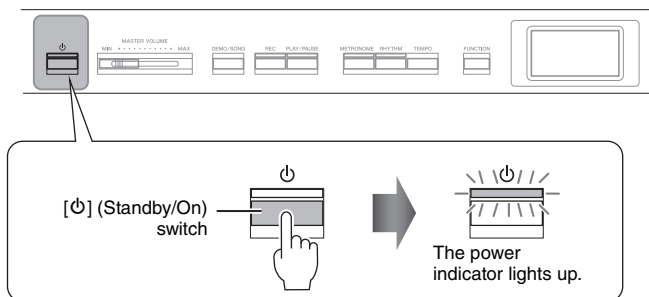

⚠ CAUTION

When setting up the product, make sure that the AC outlet you are using is easily accessible. If some trouble or malfunction occurs, immediately turn off the power switch and disconnect the plug from the outlet.

⚠ WARNING

- Use only the AC power cord supplied with your instrument. If the supplied cord is lost or damaged and needs to be replaced, contact your Yamaha dealer. The use of an inappropriate replacement can pose a fire and shock hazard!

- The type of AC power cord provided with your instrument may be different depending on the country in which it is purchased. (In some areas a plug adaptor may be provided to match the pin configuration of the AC wall outlets in your area.) Do NOT modify the plug provided with your instrument. If the plug does not fit the outlet, have a proper outlet installed by a qualified electrician.

⚠ WARNING

Use the specified adaptor (page 115) only. The use of other adaptors may result in irreparable damage to both the adaptor and the instrument.

NOTE

When disconnecting the power cord/AC adaptor, first turn off the power, then follow this procedure in reverse order.

NOTICE

- Press only the [⏻] (Standby/On) switch when turning the power on. Any other operations, such as pressing the keys, buttons or pedals may cause the instrument to malfunction.

- Turning the power off while recording or editing might cause data loss. If you need to force-quit the instrument, hold down the [⏻] (Standby/On) switch for longer than three seconds. Note that the force-quit operation might cause loss of the Paring information for *Bluetooth* audio function.

4. Play the keyboard.

While playing the keyboard, adjust the volume level by using the [MASTER VOLUME] slider. For details, refer to “Setting the volume — [MASTER VOLUME]” on page 16.

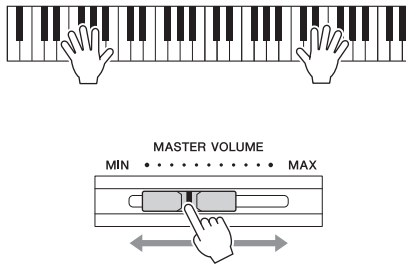

5. After you use the instrument, press and hold the [⏻] (Standby/On) switch for a second to turn the power off.

The display and the [⏻] (Standby/On) button lamp both turn off.

⚠ CAUTION

Even when the instrument is turned off, electricity is still flowing to the instrument at the minimum level. When you are not using the instrument for a long time or during electrical storms, make sure you unplug the AC power plug from the wall AC outlet.

Auto Power Off function

To prevent unnecessary power consumption, this instrument features an Auto Power Off function that automatically turns the power off if the instrument is not operated for a specified period of time. The amount of time that elapses before the power is automatically turned off is approximately 30 minutes by default; however, you can change the setting (page 102).

Disabling Auto Power Off (simple method)

Turn the power on while holding down the lowest key on the keyboard. An “Auto power off disabled” message appears briefly and Auto Power Off is disabled.

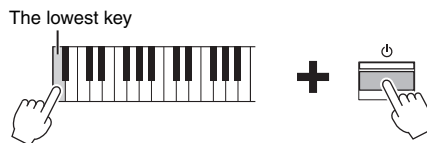

NOTICE

- Any data which are not saved will be lost if the power automatically turns off. Make sure to save your data before this happens.
- Depending on the instrument status, the power may not turn off automatically, even after the specified period of time elapses. Always turn off the power manually when the instrument is not in use.

Setting the Volume — [MASTER VOLUME]

To adjust the volume, use the [MASTER VOLUME] slider located at the right of the panel. Play the keyboard to actually produce sound while you adjust the volume.

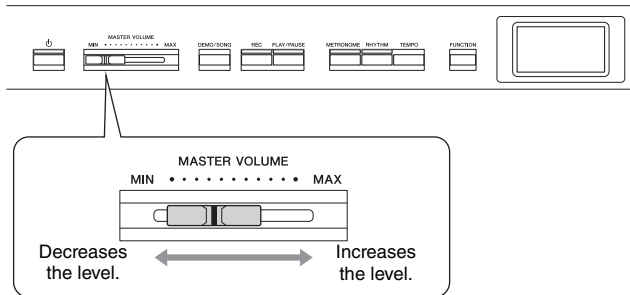

Master Volume: The volume level of the entire keyboard sound.

Adjusting the [MASTER VOLUME] slider also affects the output level of the [PHONES] jacks and the output level of the AUX OUT jacks.

⚠ CAUTION

Do not use the instrument at a high volume level for a long period of time, or your hearing may be damaged.

Intelligent Acoustic Control (IAC)

IAC is a function which automatically adjusts and controls the sound quality according to the overall volume of the instrument. Even when the volume is low, it permits both low sounds and high sounds to be clearly heard. IAC Control is effective only from the sound output of the instrument speakers.

You can set the IAC setting On or Off via the “System” menu display (page 99): Press the [FUNCTION] button repeatedly to call up the “System” menu display → “Sound” → “IAC.” The default setting for this function is “On.”

Using Headphones

Connect a pair of headphones to one of the [PHONES] jacks. When the headphones are plugged into either of the [PHONES] jacks, the internal speaker system is automatically shut off. Two [PHONES] jacks are provided. Two sets of standard stereo headphones can be plugged in. (If you are using only one pair of headphones, you can plug them into either of these jacks.)

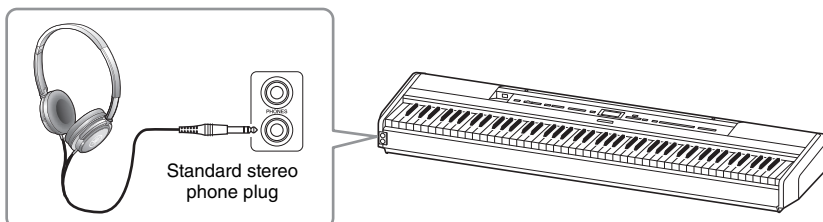

⚠ CAUTION

Do not use headphones at a high volume for an extended period of time. Doing so may cause hearing loss.

Reproducing the Natural Sensation of Sound Distance —Binaural Sampling and Stereophonic Optimizer

This instrument features two advanced technologies that allow you to enjoy exceptionally realistic, natural sound, even when listening on headphones.

Binaural Sampling (“CFX Grand” Voice only)

Binaural sampling is a method that uses two special microphones set at the ear position of a performer and records the sound from a piano as it is. Listening to the sound with this effect through headphones gives the impression of being immersed in the sound, as if it was actually emanating from the piano. Moreover, you can enjoy the sound naturally for a long time without ear strain. When the default voice, “CFX Grand” is selected, connecting the headphones automatically enables the binaural sampling sound.

Stereophonic Optimizer (Voices in the Piano group other than “CFX Grand”)

The Stereophonic Optimizer is an effect which reproduces natural sound distance like the sound of binaural sampling even though you hear it on headphones. When a Voice in the Piano group other than “CFX Grand” is selected, connecting the headphones automatically enables the Stereophonic Optimizer.

When headphones are connected, the Voices in the Piano group automatically change to the sound of Binaural Sampling or the sound enhanced with the Stereophonic Optimizer, by the default settings. However, when headphones are connected, these functions affect the sound from the external speaker connected to the AUX OUT jacks or the sound for Audio recording (page 61), and may result in those sounds sounding unusual.

If you want to turn these functions off, you can switch them on and off via the “System” menu display. Press the [FUNCTION] button repeatedly to call up the “System” menu display: “Sound” → “Binaural” (page 99).

Sampling

A technology which records the sounds of an acoustic instrument then stores them to the tone generator to be played based on information received from the keyboard.

NOTE

Voices in the Piano group are those contained in the “Piano” category in the Preset Voice List (page 107). For details about selecting Voices, refer to page 22.

NOTE

Before connecting an external powered speaker system, be sure to read “Connections” (page 72).

Using a Pedal (Footswitch)

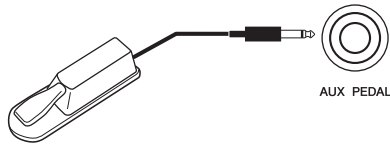

You can switch various selected functions on/off by using the included FC4A footswitch, connected to the [AUX PEDAL] jack.

Also a separately sold FC3A foot pedal or FC5 footswitch can be connected to the jack.

To select the function, use the “Aux Assign” (page 99) in the “System” menu display.

Damper Resonance

When you select a Piano Voice, pressing the footswitch activates the Damper Resonance (VRM, page 27) to accurately recreate the resonance of an acoustic piano’s strings.

You can turn the VRM effect on/off and determine the depth of the damper resonance in the Piano Room display (page 25).

Half-pedal function

This function can be used when a separately sold FC3A foot pedal or LP-1 pedal unit (page 19) is connected and allows you to vary the sustain length depending on how far the pedal is pressed. The farther down you press the pedal, the more the sound sustains. For example, if you press the damper pedal and all notes you are playing sound a bit murky and loud with too much sustain, you can release the pedal half way or higher to decrease the sustain (murkiness).

You can specify the point to which you must depress the foot pedal connected to the [AUX PEDAL] jack or the damper pedal of the pedal unit (Half Pedal Point). Press the [FUNCTION] button repeatedly to call up the “System” menu display: “Pedal” → “Half Pedal Point” (page 99).

NOTE

- Connect or disconnect the footswitch /pedal when the power of this instrument is turned off.
- Do not press the footswitch/pedal while turning the power on. Doing this changes the recognized polarity of the footswitch/pedal, resulting in reversed footswitch/pedal operation.

Default setting:

Sustain (Continuous)

NOTE

Damper Resonance cannot be used while Duo (page 32) is on.

Using the Pedal Unit (sold separately)

The [PEDAL UNIT] jack is for connecting a separately sold LP-1 pedal unit. When connecting the pedal unit, make sure to also assemble the unit on a separately sold keyboard stand (L-515).

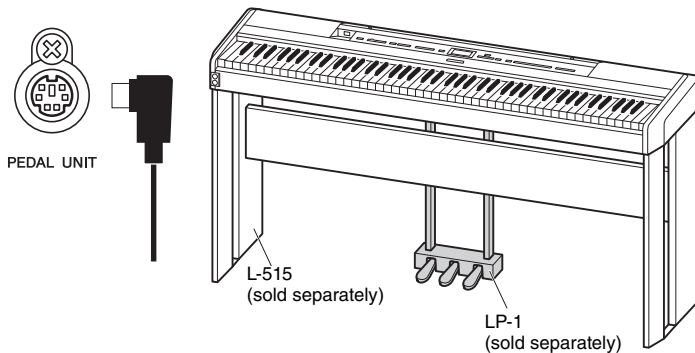

NOTE

Make sure that power is off when connecting or disconnecting the pedal unit.

Damper pedal (right pedal)

When you press the damper pedal, the notes you play have a longer sustain.

When you select a Voice in the Piano group, pressing the damper pedal activates the VRM (page 27) to accurately recreate the unique resonance of an acoustic grand piano's soundboard and strings. This pedal features Half-pedal function.

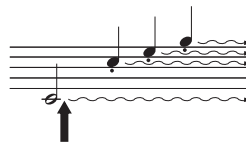

When you press the damper pedal here, the notes you play before you release the pedal have a longer sustain.

NOTE

Voices in the Piano group are those contained in the "Piano" category in the Preset Voice List (page 107). For details about selecting Voices, refer to page 22.

NOTE

You can assign other functions to each pedal by using "Pedal Assign" in "Voice" menu display (page 91).

Sostenuto pedal (center pedal)

If you play a note or chord on the keyboard and press the sostenuto pedal while holding the note(s), the notes will sustain as long as the pedal is held. All subsequent notes will not sustain.

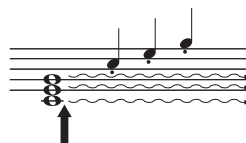

When you press the sostenuto pedal here while holding the note(s), the notes will sustain as long as you hold the pedal.

NOTE

While the sostenuto (center) pedal is held, a sustained (non-decaying) type of Voice such as strings or organ may sound continuously without decay after the notes have been released.

NOTE

The center pedal or left pedal can also be used as a [PLAY/PAUSE] button. You can assign this function via the "System" menu display: Press the [FUNCTION] button repeatedly to call up the "System" menu display: "Pedal" → "Play/Pause" (page 99).

Soft pedal (left pedal)

The soft pedal reduces the volume and slightly changes the timbre of notes played while the pedal is pressed. The soft pedal will not affect notes that are already playing when it is pressed. In order to apply this effect, play notes after pressing the pedal.

Keep in mind that this pedal function will be changed from the Soft pedal depending on the selected Voice. When the "Jazz Organ" is selected, pressing and releasing this pedal switches between "fast" and "slow" of the Rotary Speaker speed ("Rotary Speed" on page 90). When the Vibraphone is selected, this pedal switches Vibrato on and off ("VibeRotor" on page 90).

Basic Operations on Display

In addition to the front panel buttons, the instrument also features detailed control via the display menus—allowing you to select from the wealth of Voices and Songs included, as well as changing various detailed instrument settings, for even greater playability and performance potential.

Voice display

1. Press a Voice button to call up the Voice display.

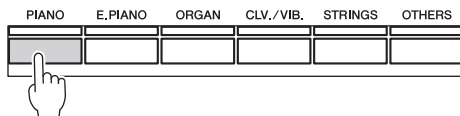

2. Use the [<]/[>] buttons to select the previous or next Voice. Press the [<]/[>] buttons simultaneously to select the first Voice in the Voice group.

Voice display



This indicates the current position in the Voice group.

Song display

1. Press the [DEMO/SONG] button to call up the Song category list.



2. Use the [^]/[v] buttons to select a Song category.



Press [>] to select a Song category.
Press [<] to return.

Detailed settings display

1. Press the [FUNCTION] button repeatedly to select the desired menu.

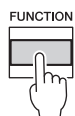

2. Use the [^]/[v] buttons to select a parameter of the current menu.



Menu name

Note that the hierarchy depth differs depending on the selected parameter.

Menu icon

You can also select the desired menu by using these alternate steps:

1. Press the [FUNCTION] button once to call up the detailed setting display.
2. Press the [<] button to highlight the menu icon, and then use the [^]/[v] buttons to select the desired menu.

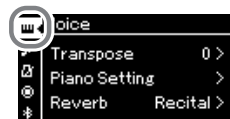

Voice display: For selecting the Voice (the sound when playing the keyboard).

Song display: For selecting the Song to playback on this instrument.

Detailed setting display: For making detailed settings for about the keyboard performance, such as Voice, or Song playback, etc. (page 88)

Return to the Voice/Song display



Press the [EXIT] button to return to the Voice display or the Song display, depending on which display was previously shown. While the pop-up window is shown, pressing the [EXIT] button closes the pop-up window.

NOTE

If your instrument is the P-515WH, the display background is white and the characters and other marks are black.

3. Use the [^]/[v] buttons to select a Song.



Press [>] to select a Song.
Press [^] to return.

When this is shown here, you can scroll through the display vertically.

4. Press [PLAY/PAUSE] button to playback the Song.

Use the [^] or [v] buttons to select the previous or next bars.



Adjusting the value on the slider pop-up window

3. Use the [<]/[>] buttons to adjust the value, press the [EXIT] button to close the pop-up window.

To reset the default value, press the [<] and [>] buttons simultaneously.

Press [>] to detailed settings.
Press [EXIT] to return to the previous display.



Press [>] to detailed settings.
Press [<] to return.

Selecting a value from a list

3. Use the [^]/[v] buttons or the [>] button to select a setting.

Press the [<] button to return to the previous display.



A checkmark is shown at the right of the selection.

Playing Various Musical Instrument Sounds (Voices)

You can select and play other musical instrument sounds (Voices), such as piano, organ, or stringed instruments.

Selecting Voices

The Voices of the instrument are conveniently divided into groups of instrument types. Select a desired Voice and play the piano. You can also select a Voice from the XG Voices. For instructions, refer to page 23.

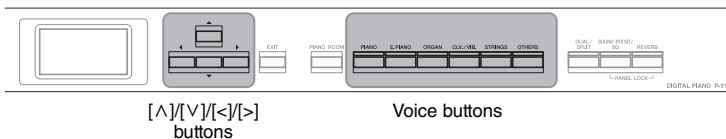

1. Press one of the Voice buttons to select the desired Voice.

Each time you press the Voice button, the Voice in the Voice group changes in order.

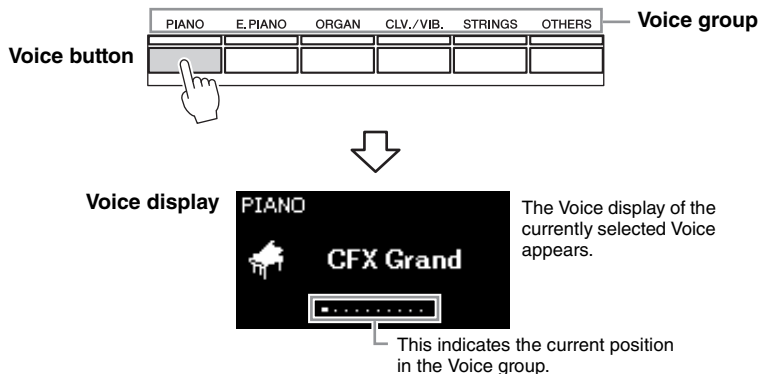

After the Voice display is called up, you can also select the Voice by using the [<]/[>] buttons. Pressing the [<]/[>] buttons simultaneously selects the first Voice in the current selected Voice group (page 107).

2. Play the keyboard.

NOTE

To hear and experience the characteristics of the Voices, listen to the Demo Songs for each Voice (page 24).

NOTE

For information about the Voices, refer to the "Preset Voice List" (page 107).

NOTE

You can specify the Touch Response (how the sound responds to the way you play the keys). For details, refer to page 36.

Selecting XG Voices

XG Voices are for playing XG (page 8) format compatible Song data. After the Voice display is called up, select a Voice from the XG Voices, following the instructions below.

1. Press the [OTHERS] button while pressing the [FUNCTION] button to call up the XG Voice group list display.

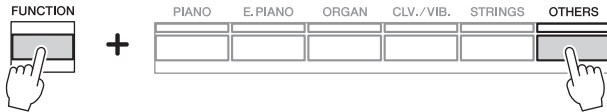

2. Use the [^]/[v] buttons to select one of the XG Voice groups, then press the [>] button.

XG Voice group list display



When this is shown here, you can scroll through the display vertically.

3. Use the [^]/[v] buttons to select the desired XG Voice, then press the [>] button.

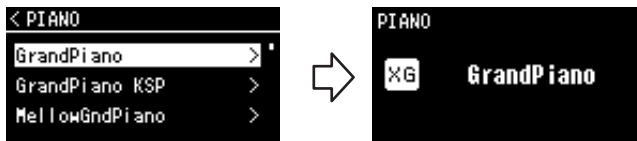

*For details on XG Voices, refer to the "XG Voice list" in the Data List on the website (page 9).

Listening to the Voice Demos

For each Voice group, the instrument contains several Demo recordings that showcase the special characteristics of the corresponding Voices. For information about the Voices which feature Demos that can be played back, refer to the “Preset Voice List” on page 107.

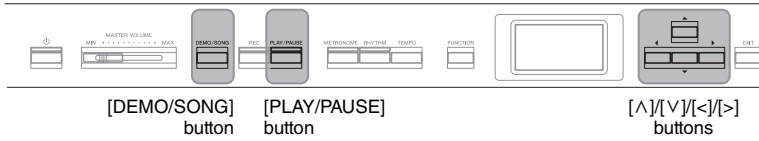

1. Press the [DEMO/SONG] button to call up the Song list display.



2. Use the [^]/[v] buttons to select “Demo,” and then press the [>] button to call up the next display.
3. Use the [^]/[v] buttons to select the desired Voice Demo, and then press the [>] button to call up the “Demo” display.

The currently selected Voice Demo name is shown in the display.



4. Press the [PLAY/PAUSE] button to start playback.
5. Press the [PLAY/PAUSE] button again to stop playback.
The Piano Demo stops automatically when Piano Demo playback reaches the end.

Selecting Other Demos

Press the [^] button to return to the Song list display, then repeat steps 3 – 4 of this section.

NOTE

Recording operations cannot be used during Voice Demo playback.

Customizing the Sound and the Touch Response of Piano Voices (Piano Room)

The Piano Room function is for those who want to simply, conveniently, and fully enjoy playing the instrument as a piano. No matter what Voice or other settings you've made, you can instantly call up the optimum settings for piano performance with a single button press. Try creating a custom piano sound by adjusting the various parameters, such as lid position, string resonance, damper resonance, touch response and so on.

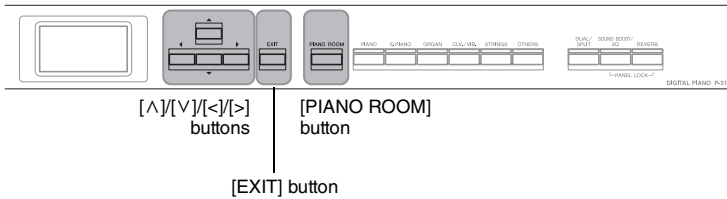

1. Press the [PIANO ROOM] button to call up the Piano Room display.



2. Press the [^]/[v] buttons to select items (page 26).
3. Press the [<]/[>] buttons to change the settings (page 26).
4. Press the [EXIT] button to exit from the Piano Room display.

NOTE







If a Voice other than in the Piano group is selected, pressing the [PIANO ROOM] button changes it to "CFX Grand."

NOTE

Pressing the [PIANO ROOM] button disables the Dual/Split/Duo functions.

What you can do in the Piano Room

You can also set the following items “Voice” menu display (page 89) or “System” menu display (page 98). If you change the settings of these items in the Piano Room display, the settings in the Voice or System display also change.

Item	Icon	Descriptions	Default settings	Setting range
Lid Position		Determines how much the Lid is opened.	Full	Full, Half, Close
Brightness		Adjusts the brilliance of sound.	5	0 – 10
Touch		Determines how the sound responds to your playing strength. You should adjust this setting according to the specific Voice you're playing or the particular Song you're performing, as desired.	Medium	Soft2, Soft1, Medium, Hard1, Hard2, Fixed
Reverb		Determines the Reverb type which is applied to all the entire sound including the keyboard performance, Song playback and MIDI data input from an external MIDI device.	Differs depending on the Voice.	Refer to the Reverb Type List (page 92)
Reverb Depth		Adjusts the Reverb depth. When “Reverb” is set to “off” or a value of “0,” no effect is produced.	Differs depending on the Voice.	0 – 127
Master Tune		Fine tunes the pitch of the entire instrument. This function is useful when you play this instrument along with other instruments or CD music.	A3 = 440.0 Hz	A3 = 414.8 Hz – 466.8 Hz (approx. 0.2 Hz steps)
VRM		Turns the VRM effect on/off. For information about the VRM function, refer to page 27. For details about the Piano Voices compatible with VRM, refer to the “Preset Voice List” on page 107. Listening to the VRM Demo You can hear the difference of VRM On/Off by pressing the [PLAY/PAUSE] button while VRM On/Off display is being displayed. If you press the [PLAY/PAUSE] button while VRM is On, the Demo Song of VRM On will play back. If you press the [PLAY/PAUSE] button while VRM Off, the Demo Song of VRM Off will play back.	On	On, Off
Damper Res.		Determines the depth of the string resonance effect which is applied when the damper pedal is pressed. This parameter can be set when VRM is on.	5	0 – 10
String Res.		Determines the depth of the string resonance effect which is applied when a note on the keyboard is pressed. This parameter can be set when VRM is on.	5	0 – 10
Aliquot Res.		Adjusts the sympathetic vibrations of the Aliquot resonance effect. For details about Aliquot, refer to “What is Aliquot?” (page 27).	5	0 – 10
Body Res.		Adjusts the resonance of the piano itself, i.e. soundboard, the sides, the frame and so on. This parameter can be set when VRM is on.	5	0 – 10
Key Off Sample		Determines the volume of the key-off sound (the subtle sound that occurs when you release a key) which is available only for some Voices. For Voices to which this effect is applied, refer to the Voice List (page 107).	5	0 – 10



Item	Icon	Descriptions	Default settings	Setting range
Half Pedal Point		Specify the point to which you must depress the right pedal before the effect of "Sustain (Continuous)" begins to be applied. This setting applies only to the "Sustain (Continuous)" effect (page 92) that is assigned to the right pedal.	0	-2 (effective with the shallowest press) – 0 – +4 (effective with the deepest press)

What is VRM?

On a actual grand piano, if you press the damper pedal and play a key, not only does the string of the pressed key vibrate, it also causes other strings and the soundboard to vibrate, with each influencing the rest, creating a rich and brilliant resonance that sustains and expands. The VRM (Virtual Resonance Modeling) technology featured in this instrument reproduces the complicated interaction between both string and soundboard resonance, and make the sound more like that of a real acoustic grand piano. Since resonance instantaneously occurs depending on the action of the keys and pedal, you can expressively vary the sound by changing the timing of your pressing the keys, and the timing and depth of your pressing the pedal.

What is Aliquot?

Aliquot is a stringing method for pianos that uses extra, un-struck strings in the upper octaves to enhance the tone. These strings sympathetically vibrate with other strings in an acoustic piano, resonating with overtones, and adding richness, brilliance and complex color to the sound. Since they do not have a damper, they will continue sounding even after you release your hands from the keyboard.

Enhancing and Customizing the Sound

Applying the following effects gives you greater and richer expressive capabilities.

Reverb

This control adds reverberation to the sound by simulating the natural reverberation of a concert hall. The ideal Reverb type is automatically selected whenever you select a Voice, but you can select any of the available Reverb types.

To select a desired Reverb type, press the [REVERB] button to call up the “Reverb” display. You can also select the Reverb type for Voices in the Piano group from the Piano Room display (page 26).

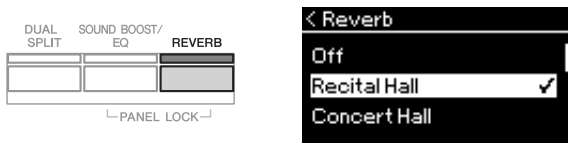

This setting is applied commonly to all parts (keyboard Voices/Song/MIDI).

Chorus

This control adds warmth and spaciousness to the sound. The ideal Chorus type is automatically selected whenever you select a Voice, but you can select any of the available Chorus types.

To select a desired Chorus type, use the “Voice” menu display: “Chorus” (page 89).

This setting is applied commonly to all parts (keyboard Voices/Song/MIDI).

Effects

This instrument features a wide variety of Effects, letting you apply enhancements such as Echo or Tremolo to the selected Voice for your keyboard performance. You can select any of the available Effect types from the “Voice” menu display: “Voice Edit” → “Effect” (page 90).

NOTE

- You can adjust the Reverb depth for the selected Voice from the “Voice” menu display: “Voice Edit” → “Reverb Depth” (page 90).
- If you change the Reverb type of Piano group Voices here, the type in the Piano Room display (page 26) is also changed.

NOTE

You can adjust the Chorus depth for the selected Voice from the “Voice” menu display: “Voice Edit” → “Chorus Depth” (page 90).

NOTE

When you want to apply the Chorus effect to a Voice whose Chorus type is set to off by default, set the Chorus type to something other than “Off,” then set the Chorus depth value as desired (greater than “0”).

Playing Two Voices Simultaneously (Dual)

Two Voices can be played simultaneously. You can create warm and richly textured Voices by using Voices from different groups simultaneously in a layer, or by using Voices in the same group.

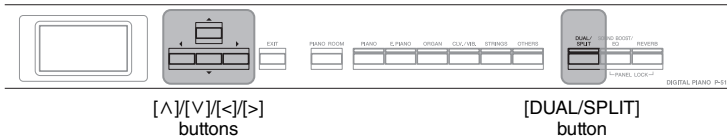

1. To enter the Dual mode, press the [DUAL/SPLIT] button once.

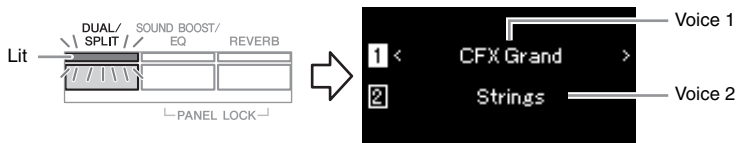

The Voice which is displayed at top is Voice 1, and the one at bottom is Voice 2.

2. Select the Voices for layering.
 - 2-1. Use the [^]/[V] buttons to highlight 1 (Voice 1) in the display.
 - 2-2. Use the Voice button to select the desired Voice (page 22).
 - 2-3. Use the [^]/[V] buttons to highlight 2 (Voice 2), and then select a Voice according to step 2-2.
3. Play the keyboard.
4. To exit from the Dual mode, press the [DUAL/SPLIT] button repeatedly to turn the lamp off.

NOTE

You can also enter the Dual mode by pressing the two Voice buttons simultaneously.

Splitting the Keyboard Range and Playing Two Different Voices (Split Mode)

Split mode enables you to play two different Voices on the keyboard—one with your left hand and another with your right.

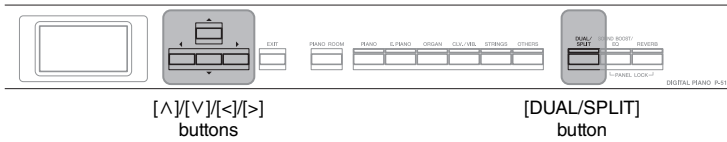

1. To enter the Split mode, press the [DUAL/SPLIT] button twice.

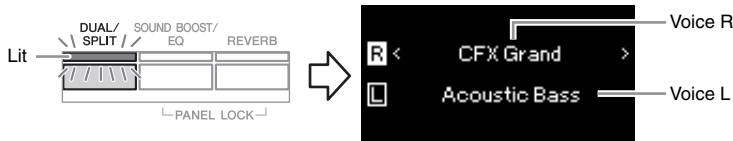

The Voice which is displayed at top is Voice R, and the one at bottom is Voice L.

2. Select a Voice for the right-hand area and left-hand area.

The border between the right- and left-hand ranges is referred to as "Split Point." The Split Point key (F #2 as default) is included in the left-hand range.

 - 2-1. Use the [^]/[V] buttons to highlight **R** (Voice R) in the display.
 - 2-2. Use the Voice button to select the desired Voice (page 22).
 - 2-3. Use the [^]/[V] buttons to highlight **L** (Voice L), and then select a Voice according to step 2-2.
3. Play the keyboard.

Changing the Split Point

You can change the Split Point from the default setting "F #2" to any other key. While in the Split mode, hold down the [DUAL/SPLIT] button, and press the key you wish to assign as the Split Point.

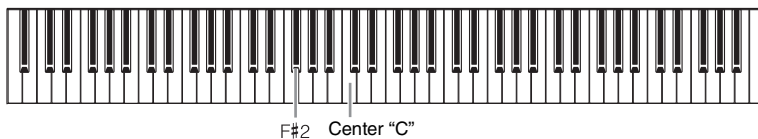

NOTE

The Split Point can also be set via the "System" menu display: Press the [FUNCTION] button repeatedly to call up the "System" menu display → "Keyboard" → "Split Point" (page 99).

4. To exit from the Split mode, press the [DUAL/SPLIT] button repeatedly so that the lamp turns off.

Using Dual and Split Simultaneously

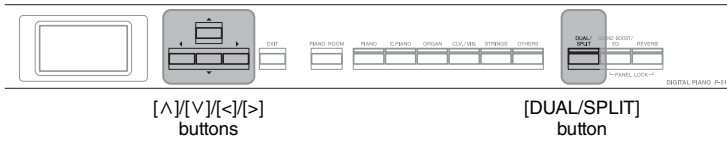

1. To use both the Dual and Split modes simultaneously, press the [DUAL/SPLIT] button three times.

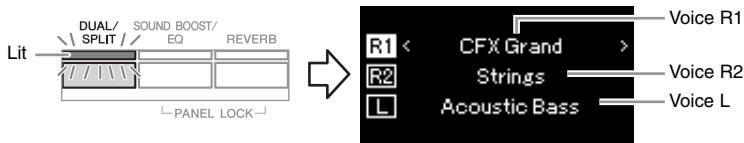

The Voice which is displayed at top is Voice R1, and the one in the middle is Voice R2, and the one at bottom is Voice L.

2. Select the Voices for layering and for the left-hand area.
 - 2-1. Use the [^]/[V] buttons to highlight **R1** (Voice R1) in the display.
 - 2-2. Use the Voice button to select the desired Voice (page 22).
 - 2-3. Use the [^]/[V] button to highlight **R2** (Voice R2) or **L** (Voice L), and then select Voices according to step 2-2.
3. Play the keyboard.
4. Press the [DUAL/SPLIT] button to exit from the Dual and Split mode.
The lamp of the [DUAL/SPLIT] button turns off.

NOTE

The specified Split Point key is included in the left-hand range.

NOTE

For the information on setting the Split Point, refer to page 30.

Playing Duo

This function allows two different players to play the instrument, one on the left and the other on the right. This is convenient for practicing duets over the same octave range.

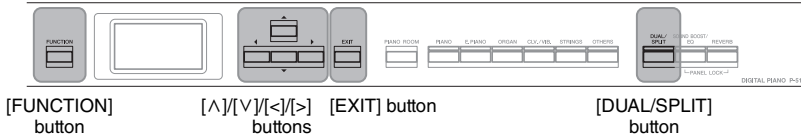

1. Press the [FUNCTION] button repeatedly to call the “System” menu display, and then select the highlighted item in each display as illustrated below.

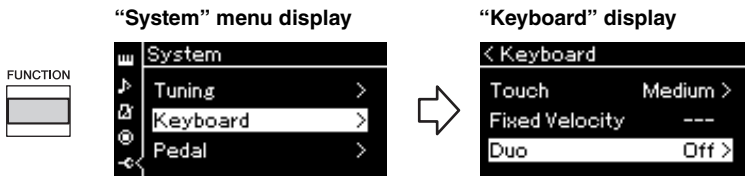

- 1-1. Use the [^]/[v] buttons to select “Keyboard.”
- 1-2. Press the [>] button to call up the next display.
- 1-3. Use the [^]/[v] buttons to select “Duo.”
- 1-4. Press the [>] button to select “On.”
[DUAL/SPLIT] button lights in blue.

The keyboard is divided into two sections, with the E3 key as the Split Point.

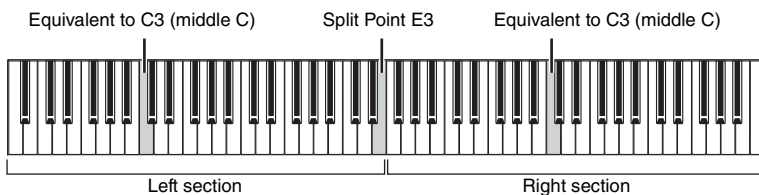

When using the included footswitch or separately sold footswitch/pedal, you can determine the keyboard area to which the function of the footswitch/pedal is applied.

Refer to “Aux Area” on page 99 for details.

When using the separately sold pedal unit, the pedal function changes as follows.

Right Pedal	Damper pedal for the right-hand range
Center Pedal	Damper pedal for both the right-hand and left hand ranges
Left Pedal	Damper pedal for the left-hand range

NOTE

While Duo is on, the Reverb, VRM and Stereophonic Optimizer functions are disabled (page 17).

NOTE

The specified Split Point key is included in the left-hand range.

Aux Area

Default setting: All

Setting range: All, Right, Left

2. Press the [EXIT] button to call up the Voice display, and then press the Voice button to select the desired Voice.

When Duo is on, the [Duo] indication is shown on the Voice display.



3. Play the keyboard.

The sound of left-hand range is emitted from the left, the sound of right-hand range is emitted from the right.

4. Press the [DUAL/SPLIT] button to exit from the Duo mode.

You can also exit from the Duo mode by following either of the instructions below.

- Press the [PIANO ROOM] button.
- Repeat the same procedure from step 1 to set it to "Off."

Transposing the Pitch in Semitones (Transpose)

You can shift the pitch of the entire keyboard up or down in semitone intervals to facilitate playing in difficult key signatures, and to let you easily match the pitch of the keyboard to the range of a singer or other instruments. For example, if you set this parameter to “5”, playing key C produces pitch F. In this way, you can play the F major song as if it were in C major.

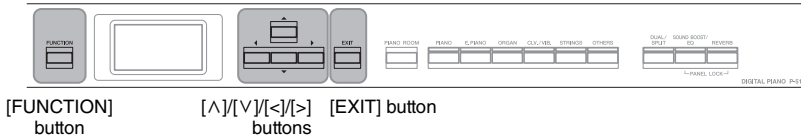

1. Press the [FUNCTION] button repeatedly to call up the “Voice” menu display. Select “Transpose,” and then press the [>] button.

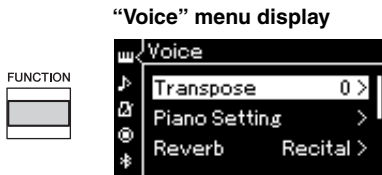

2. Set the Transpose amount by using the [<]/[>] buttons. To reset the parameter to the default setting, press the [<] and [>] buttons simultaneously.



3. Press the [EXIT] button to close the “Transpose” display.

Default setting: 0
Setting range: -12 (-1 octave) – 0 (normal pitch) – +12 (+1 octave)

NOTE

The setting made here does not affect Song playback. If you want to transpose Song playback, use the Transpose parameter in the “Song” menu (page 93).

NOTE

Your keyboard performance data will be transmitted with the transposed note numbers while MIDI note numbers received from an external MIDI device or computer will not be affected by the Transpose setting.

Fine Tuning the Pitch (Master Tune)

You can fine-tune the pitch of the entire instrument. This function is useful when you play this instrument along with other instruments or recorded music.

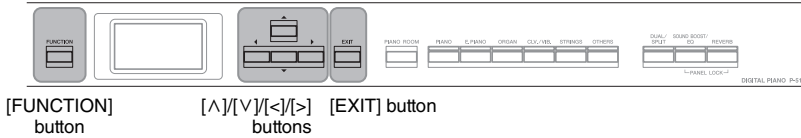

1. Press the [FUNCTION] button repeatedly to call up the “System” menu display. Select “Tuning” by using the [^]/[v] buttons and then press the [>] button.

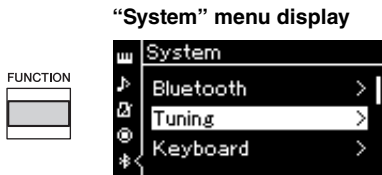

2. Use the [^]/[v] buttons to select the “Master Tune,” then press the [>] button.

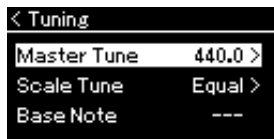

3. Set the tuning value by using the [<]/[>] buttons. To reset the value to the default setting (A3=440.0Hz), press the [<]/[>] buttons simultaneously.



4. Press the [EXIT] button to close the “Master Tune” display.

Default setting: A3=440.0Hz
Setting range: A3=414.8Hz – 440.0Hz – 466.8Hz (in approximately 0.2 Hz increments)

NOTE

- If you change the tuning value here, the value in the Piano Room display (page 26) is also changed.
- These settings will not be applied to the Drum Kit Voices or Audio Song. Also, these settings will not be recorded to a MIDI Song.

Changing the Touch Sensitivity (Touch)

You can determine how the sound responds to your playing strength. This setting does not change the weight of the keyboard.

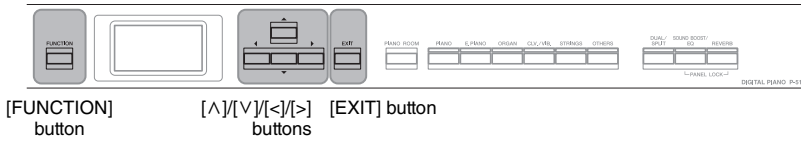

1. Press the [FUNCTION] button repeatedly to call up the “System” menu display. Select “Keyboard” by using the [^]/[v] buttons, and then press the [>] button.

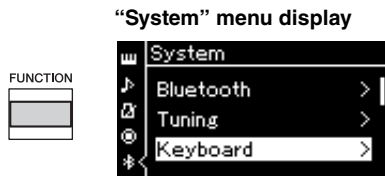

2. Select “Touch” by using the [^]/[v] buttons, and then press the [>] button.

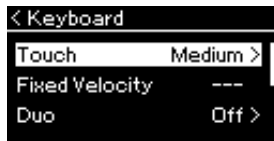

3. Use the [^]/[v] buttons to determine the touch sensitivity.

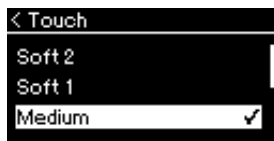

Touch Sensitivity list

Soft 2	Produces relatively high volume even with light playing strength.
Soft 1	Produces high volume with moderate playing strength.
Medium	Standard touch sensitivity.
Hard 1	Requires moderately strong playing for high volume.
Hard 2	Requires strong playing to produce high volume.
Fixed	No touch response. The volume level will be the same regardless of how hard you play the keys.

4. Press the [EXIT] button to exit from the “Touch” display.

NOTE

When playing with Piano Voices, you can also determine the touch sensitivity in the Piano Room display. For details, refer to “What you can do in the Piano Room” on page 26.

Default setting: Medium

NOTE

- If you change the touch sensitivity here, the setting in the Piano Room display (page 26) is also changed
- The setting here will not be recorded to a MIDI Song nor be transmitted as MIDI messages.
- The touch sensitivity settings may have no effect with Organ or Harpsichord Voices.

Boosting the Overall Sound (SOUND BOOST)

By using the Sound Boost function when playing along with other instruments, you can raise the volume and enhance the presence of your performance without losing any of the expressive range. This function is particularly useful when you want all the notes you play—both loud and soft—to be clearly audible.

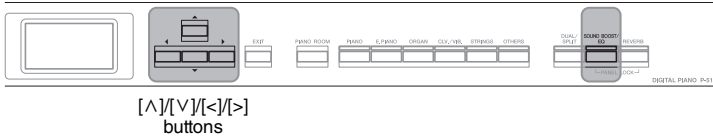

1. Press the [SOUND BOOST/EQ] button once to call up the “Sound Boost” display, and then press the [^] button to highlight “On/Off.”

Default setting: Off

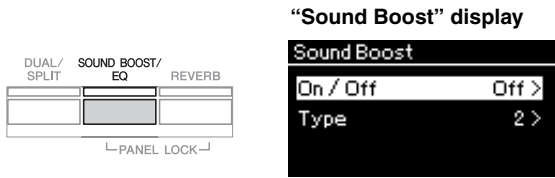

2. Press the [>] button to turn on the Sound Boost function. The [SOUND BOOST/EQ] button lights.
3. Press the [v] button to highlight “Type.”
4. Press the [>] button to call up the “Type” display, then use the [^]/[v] buttons to select the Sound Boost type.

Default setting: 2



Sound Boost type list

1	Producing smooth dynamics, this type is ideal for solo performances of energetic songs.
2	This type produces a smoother, clearer sound than Type 1, making it the perfect choice when singing and playing at the same time.
3	In addition to brighter, more-powerful sound than Type 2, this type also has a clearer attack — ideal when performing as part of a band.

5. Press the [EXIT] button to exit from the “Type” display.

Adjusting the Sound (Master EQ)

The EQ (Equalizer) processes the sound by dividing the frequency spectrum into multiple bands, allowing you to boost or cut them as required to tailor the overall frequency response and provide optimum sound when listening through the instrument’s internal speaker, or headphones, etc.

This instrument possesses a three-band digital EQ. You can select one of the three preset EQ types in the “Master EQ” display. You can even create your own custom EQ settings by adjusting the frequency bands, and save the settings to the User Master EQ.

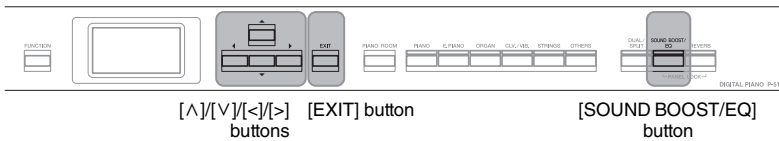

Selecting the Master EQ type

1. Press the [SOUND BOOST/EQ] button twice to call up the “Master EQ” display.



Default setting: Flat

2. Use the [^]/[v] buttons to select the Master EQ type.

Master EQ type list

Flat	Flat, unprocessed EQ settings.
Bright	EQ settings providing bright sound.
Mellow	EQ settings providing mellow sound.
User	Your own custom EQ settings saved in “Setting the User Master EQ” (page 39).

3. Press the [EXIT] button to exit from the “Master EQ” display.

Setting the User Master EQ

1. Press the [V] button to select “User” in the “Master EQ” display, then press the [>] button to call up the User display in which the three bands can be boosted or cut.

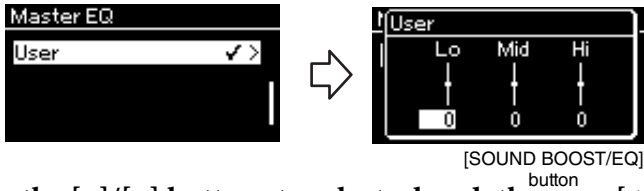

2. Use the [<]/[>] buttons to select a band, then use [^]/[V] buttons to boost or cut it.

To reset the setting to the default, press the [^]/[V] buttons simultaneously.



3. Press the [EXIT] button to close the “User” display.

Default setting: 0 dB
Setting range: -6 dB – 0 – +6 dB

Locking the Front Panel

As described below, your instrument's Panel Lock function allows you temporarily disable the front panel buttons to prevent them being operated unintentionally while performing.



1. Press the [SOUND BOOST/EQ] and [REVERB] buttons simultaneously to lock the front panel.

The Voice display appears on the instrument's display, and the lock icon is shown at the lower right on the display.

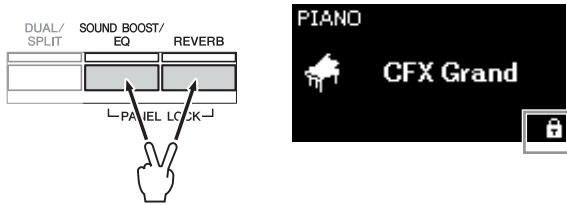

All front panel buttons with the exception of the [ϕ] (Standby/On) switch will be disabled.

2. Press the [SOUND BOOST/EQ] and [REVERB] buttons simultaneously again to unlock the front panel.

NOTE

- It is impossible to lock the front panel during Song playback and recording.
- When the front panel is locked during playback of the metronome, rhythm, and Song, playback cannot be stopped until the panel is unlocked.
- When the front panel is locked, it is impossible to switch between Song playback/pause by using the Aux pedal function (page 99).
- Even if the front panel is locked, when the Auto Power Off function (page 15) is on, the power is automatically turned off.

Using the Metronome

The instrument has a built-in metronome (a device that keeps an accurate tempo)—a convenient tool for practice.



1. **Press the [METRONOME] button to start the metronome.**
This calls up the “Tempo” display, from which you can adjust the tempo. For details, see next section.



2. **Press the [METRONOME] button again to stop the metronome.**
To exit from the “Tempo” display, press the [EXIT] button.

NOTE

For information on setting the time signature, refer to page 42.

NOTE

You can set the metronome volume, BPM and so on from the “Metronome/Rhythm” menu display (page 96).

Adjusting the Tempo

1. **Press the [TEMPO] button to call up the “Tempo” display.**

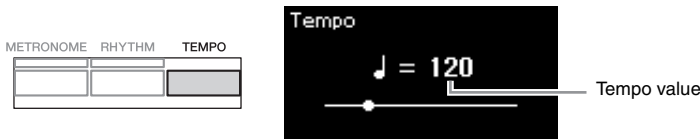

2. **Use the [←]/[>] buttons to adjust the tempo.**
To reset the tempo to the default setting, press the [←] and [>] buttons simultaneously.
3. **Press the [EXIT] button to exit from the Tempo display.**

Setting range: Depends on the time signature (page 42).

Setting the metronome time signature

1. Press the [FUNCTION] button repeatedly to call up the “Metronome/Rhythm” menu display. Select the “Time Sig.,” and then press the [>] button.

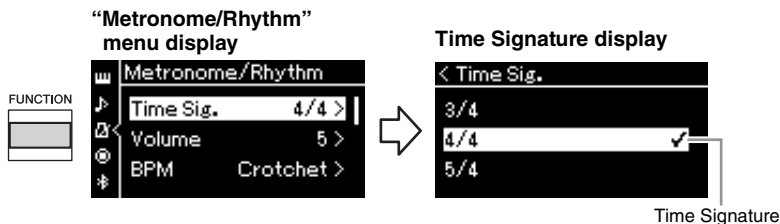

2. Use the [^]/[v] buttons to select the desired time signature.

Setting range: 2/2, 1/4, 2/4, 3/4, 4/4, 5/4, 6/4, 7/4, 3/8, 6/8, 7/8, 9/8, 12/8

Default setting: 4/4 (Selecting a MIDI Song will change the tempo value to that specified in the selected MIDI Song data.)

Tempo indication and Setting range

When pressing the [TEMPO] button, the tempo is displayed as “note type=xxx” (For example: ♩ =120). Selecting the Time Signature changes the available parameters as follows.

Note type	Time Signature	Setting range
♩ Half note	2/2	3 – 250
♩ Quarter note	1/4, 2/4, 3/4, 4/4, 5/4, 6/4, 7/4	5 – 500
♩ Dotted quarter note	6/8, 9/8, 12/8	4 – 332 (even numbers only)
♩ Eighth note	3/8, 7/8	10 – 998 (even numbers only) and 999

- * When the tempo value of the selected MIDI Song is outside the setting range on the instrument, the value will be changed to fit within the setting range.
- * Note type will be fixed to quarter note as long as the “BPM” parameter in the “Metronome/Rhythm” menu display is set to “Crotchet” regardless of the Time Signature you set.

3. Turn the “Bell” setting on.
For details, refer to “Bell” in the “Metronome/Rhythm” menu (page 96). The Metronome plays back according to the selected Time Signature with the Bell sound on the first beat of each measure.
4. Press the [EXIT] button to exit from the “Metronome/Rhythm” menu display.

Note type

The length of one beat

Metronome detailed settings

You can set the metronome volume, BPM and so on from the “Metronome/Rhythm” menu display (page 96).

Playing the Keyboard along with Rhythm Playback

You can select a Rhythm from a variety of musical genres, such as Pops and Jazz, and play along with it. Refer to “Rhythm List” on page 109.

For this instrument, Rhythm refers to drums and bass accompaniment.

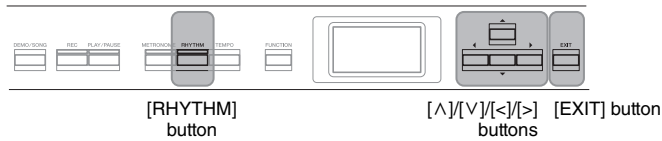

1. Press the [RHYTHM] button to start Rhythm playback.

Intro playback starts followed by the Rhythm playback.



To set the Intro/Ending on or off

“Intro” and “Ending” allow you to vary the arrangement of the accompaniment. You can set “Intro” and “Ending” on/off via “Intro” or “Ending” in the “Metronome/Rhythm” menu display (page 96).

2. Use the [<]/[>] buttons to call up the desired Rhythm.

For details on the available Rhythms, refer to the Rhythm List (page 109).

3. Play the keyboard along with Rhythm playback.

The instrument will automatically create appropriate accompaniment bass sound while you play, based on the chords you play.

The default setting of the bass sound is “On.”

If you don’t want to have the bass accompaniment sound, set it to “Off”. Press the [FUNCTION] button repeatedly to call up the “Metronome/Rhythm” menu display. Select “Bass,” and then press [>] button to switch on/off.

4. To stop Rhythm playback, press the [RHYTHM] button again.

The Rhythm will automatically stop after the Ending is played.

5. Press the [EXIT] button to exit from the “Rhythm” display.

About the Rhythm Tempo

- The Rhythm tempo is equivalent to that set for the Metronome (page 41).
- Although you set the Rhythm tempo, selecting a MIDI Song will change the tempo value to that specified in the selected MIDI Song data.
- When you press the [TEMPO] button to call up the “Tempo” display to change the Rhythm tempo, during Rhythm playback, press the [EXIT] button to return to the “Rhythm” display from the “Tempo” display.

Detailed Settings for the Rhythm

From the “Metronome/Rhythm” menu display (page 96), you can set detailed parameters, such as Rhythm volume and Sync Start, with which pressing a key will start Rhythm playback.

NOTE

The “Rhythm” display cannot be called up during the Song playback or recording.

NOTE

- Some arrangements may not be suitable for use with this feature.
- 9th, 11th and 13th chords cannot be played.
- For details on how to play chords, refer to commercially available chord books.

Playing Back Songs

This instrument can play Preset Songs, Songs you recorded on this instrument, or commercially available Songs. In addition to listening to these Songs, you can play the keyboard as the Song plays back.

MIDI Songs and Audio Songs

There are two kinds of Songs that can be recorded and played back on this instrument: MIDI Songs and Audio Songs.

A MIDI Song is comprised of your keyboard performance information and is not a recording of the actual sound itself. The performance information refers to which keys are played, at what timing, and at what strength—just as in a musical score.

Based on the recorded performance information, the tone generator (of the Clavinova, etc.) outputs the corresponding sound. A MIDI Song uses a small amount of data capacity in comparison to an Audio song, and allows you to easily change aspects of the sound, such as Voices used, etc.

An Audio Song is a recording of the performed sound itself. This data is recorded in the same way as that used in recording cassette tapes, or with voice recorders, etc.

This data can be played with a portable music player, etc., allowing you to easily let other people hear your performance.

You can play back the following types of Songs in this instrument.

- Preset Voice Demo Songs (Voice Demo).
- Preset Songs: 50 classical Preset Songs (“50 Classics”)
- Your own recorded Songs (see page 54 for instructions on recording)
- Commercially available MIDI Song data: SMF (Standard MIDI File)
The maximum size for playback on this instrument is approx. 500KB per single MIDI Song.
- Commercially available Audio Song data: Wav (file extension = .wav with 44.1 kHz sample rate, 16-bit resolution, stereo, and maximum 80 minutes length)

Availability of functions differs between MIDI Songs and Audio Songs. In this chapter, the following icons indicate whether or not the explanation applies to MIDI Songs or Audio Songs individually.

Example:

MIDI

Audio

Indicates explanation applies only to MIDI Songs

Playback of Songs

MIDI | Audio

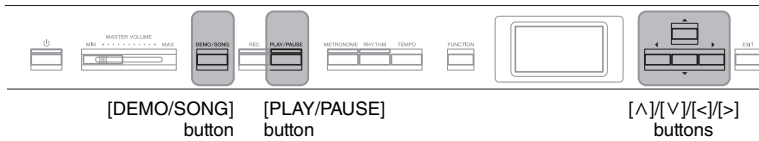

1. If you want to play back a Song in a USB flash drive, connect the USB flash drive containing Song data to the [↔] (USB TO DEVICE) terminal beforehand.

Audio files to be played must be on a USB flash drive.

2. Press the [DEMO/SONG] button to call up the Song List display, then select the desired category using [^]/[v] buttons.

Select the desired one from “50 Classics,” “User” or “USB” referring to the category descriptions below.

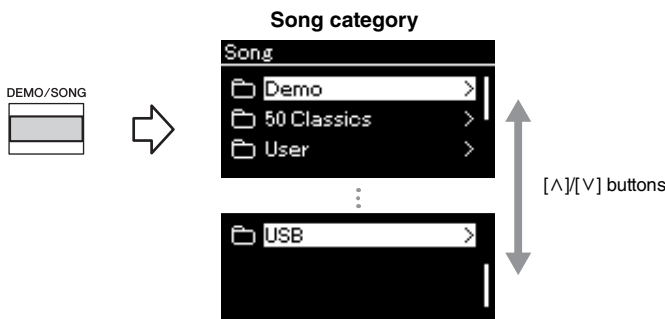

Demo	Voice Demos let you experience the characteristics of the Voices (MIDI Song) (page 24).
50 Classics	50 classical Preset Songs (MIDI Songs). For details, refer to the “Song List” on page 109.
User	MIDI Songs which have been recorded and saved to the instrument by using the Recording function (page 54), and MIDI Songs which have been copied/moved to the instrument using File operations (page 66).
USB	MIDI/Audio Songs saved to the USB flash drive by recording them with this instrument or Audio Songs converted from MIDI Songs (page 70), or MIDI/Audio Songs saved to the USB flash drive.

NOTE

The instrument can automatically select a Song file saved in the root directory of the USB flash drive as soon as the USB flash drive is connected. For instructions, refer to “USB Autoload” on page 101.

NOTE

Before using a USB flash drive, be sure to read “Connecting USB Devices ([↔] (USB TO DEVICE) terminal)” on page 74.

NOTE

USB folder appears only when USB flash drive is connected to the [↔] (USB TO DEVICE) terminal.

3. Press the [>] button to display the Songs in the specified category, and then select a desired Song using the [^]/[v] buttons.

When “User” or “USB” category is selected, the icon indicating Song types are shown to the left of the Song name.

Song List

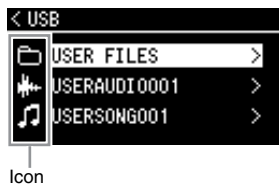

icon	Data format
	Folder
	MIDI Songs
	Audio Songs

To select a recorded Song saved to USB flash drive:

When you record a Song and save it to a USB flash drive, the recorded Song will automatically be saved to the USER FILES folder on a USB flash drive. If you want to select the Song from the USER FILES folder, select USB in step 2, and USER FILES folder in step 3.

4. Press the [>] button to select the desired Song.

The Song display is shown letting you to see the currently selected Song name and its category name.

Song display: MIDI Song

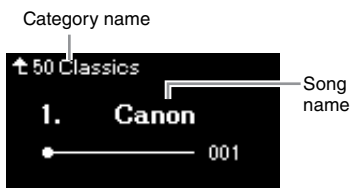

Song display: Audio Song

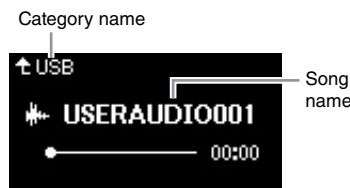

5. Press the [PLAY/PAUSE] button to start playback.

The current position of the Song playback will be shown.

Song display: MIDI Song

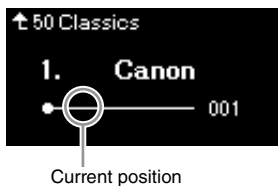

Song display: Audio Song

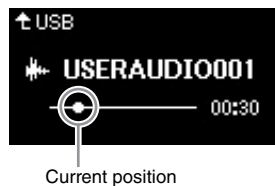

You can play the keyboard along with Song playback. You can also change the Voice for your keyboard performance. To adjust the volume balance between your keyboard performance and MIDI Song playback, or to adjust the Audio Volume, set the appropriate Volume parameters individually in the “Song” menu display (page 52).

NOTE

Press the [<] button to return to the category/folder.

NOTE

“NoSong” will be shown in the display when no data exists in that folder.

When Songs cannot be read from a USB flash drive

If the song cannot be read, you may need to change the Language setting for the Song name in the “System” menu display (page 102).

NOTE

Press the [^] button to return to the Song list.

NOTE

- When the Song title is too long to be displayed, press the [v] button to see the full title.
- Songs having titles longer than 47 characters cannot be played on this instrument.

NOTE

If a Song has been selected, the original tempo of the Song is used, and the Metronome setting (page 41) will be ignored.

- Press the [PLAY/PAUSE] button again to stop playback.
Even if you don't press the [PLAY/PAUSE] button, the Song stops automatically when Song playback reaches the end.

NOTE

Useful playback functions are described on pages 48 – 53.

NOTE

Pressing the [<] and [>] buttons simultaneously returns to the top position of the Song.

Rewind/Fast forward

- Use the [<] and [>] buttons to move back or forth through the Song (in bars or seconds), while the Song display is shown.

Song display: MIDI Song

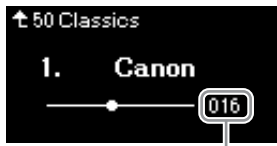

Measure number

Song display: Audio Song



Elapsed time

Holding one of the buttons scrolls backward/forward continuously. Pressing the [<] and [>] buttons simultaneously returns to the top position of the Song.

Adjusting the tempo

You can adjust the playback tempo of a Song.

- Press the [TEMPO] button to call up the “Tempo” display.
For a MIDI Song, press the [TEMPO] button during Song playback or while the Song display is shown. For an Audio Song, press the [TEMPO] button during Song playback.

NOTE

Changing the tempo of an Audio Song may change its tonal characteristics.

MIDI Song

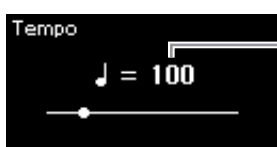

Tempo

Audio Song



Tempo

- Change the Tempo value using the [<]/[>] buttons.

The original tempo of the current Song can be recalled by pressing the [<] and [>] buttons simultaneously.

When a MIDI Song is selected, the tempo range differs depending on the Time Signature for a selected Song.

When an Audio Song is selected, the tempo range is between 75% – 125%. 100% is the original tempo value. Higher values result in a faster tempo.

NOTE

Available setting values may only include even numbers (multiples of 2), depending on the Time Signature. For more information, refer to page 42.

- Press the [EXIT] button to exit from the “Tempo” display.

Playing a One-hand Part — Part Cancel Function (MIDI Songs)

MIDI Audio

Some MIDI Songs, such as Preset Songs, are divided into right-hand and left-hand parts. By using such Song data, you can practice the left hand by turning on only the right-hand part, and practice the right hand by turning on only the left-hand part—allowing you to practice parts separately for easy mastery of difficult material.

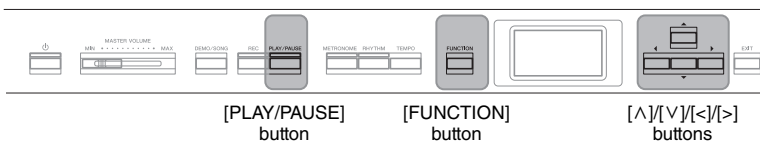

1. Select a Song for practicing.

For instructions, refer to page 45. The Song category “50 Classics” is recommended.

2. Select a part you want to practice, then set the part to off.

Press the [FUNCTION] button repeatedly to call up the “Song” menu display, then select the highlighted item in each display as illustrated below.

In the “L/R” display, select the part (track) you want to mute for practicing. Select “R” for practicing the right-hand part, or “L” for the left-hand part.

“Song” menu display

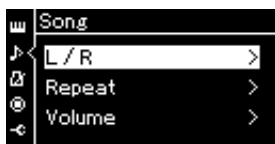

“L/R” display



2-1. Use the [^]/[v] buttons to select “L/R.”

2-2. Press the [>] button to call up the next display.

2-3. Use the [^]/[v] buttons to select desired track.

3. Use the [>] button to select “Off” for the selected part.

4. Press the [PLAY/PAUSE] button to start playback.

Play and practice the part you just muted.

5. Press the [PLAY/PAUSE] button again to stop playback.

Even if you don’t press the [PLAY/PAUSE] button, the Song stops automatically when Song playback reaches the end.

NOTE

The parts can be turned on or off even during playback.

NOTE

Usually, Channel 1 is assigned to “R,” Channel 2 is assigned to “L,” and Channels 3 – 16 are assigned to “Extra.” However, the assignments may differ depending on the particular Song. Channels assigned to “Extra” cannot be set to on or off individually.

NOTE

Some songs in “50 Classics” are duet songs. Refer to page 109 about part assignment for the duet songs.

NOTE

Whenever you select another MIDI Song, both parts are automatically turned on.

Playing Back a Song Repeatedly

There are three Repeat items as follows. These are convenient for repeatedly practicing difficult phrases. It is a good idea to use this function and the Part Cancel function (above) for practicing difficult phrases, in the case of MIDI Songs.

- **AB Repeat** Play a MIDI Song repeatedly by designating a specific range within the Song.
- **Phrase Repeat** Play a MIDI Song repeatedly by designating a phrase or phrases within the Song.
- **Song Repeat** Play a MIDI/Audio Song repeatedly, or play all MIDI/Audio Songs saved in a designated folder repeatedly in order or in random order.

The explanations here apply only to AB Repeat and Song Repeat. For Phrase Repeat, refer to page 93.

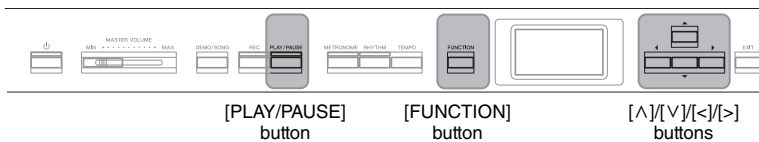

1. Select a Song to be played back.

For instructions, refer to page 45.

2. Call up the “Repeat” display.

Press the [FUNCTION] button repeatedly to call up the “Song” menu display. Select “Repeat,” then press the [>] button.

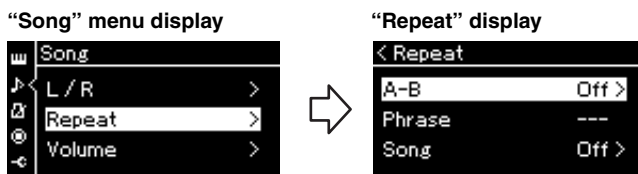

3. In the “Repeat” display, select a desired item using the [^]/[v] buttons, then press the [>] button.

If you want to set AB Repeat, select “A – B.”
If you want to set Song Repeat, select “Song.”

4. Set in the appropriate setting display.

- **AB Repeat** See below.
- **Song Repeat** See page 51.

AB Repeat setting

MIDI

Audio

Specify the repeat range.

4-1. Press the [PLAY/PAUSE] button to start Song playback.

4-2. Press the [>] button at the starting point (A) of the range to be repeated.

“A-B” display



4-3. Press the [>] button again at the ending point (B).

After an automatic lead-in (to help guide you into the phrase), the range from Point A to Point B is played back repeatedly.

5. To turn off the Repeat function, press the [>] button while “Repeat Off” is highlighted, or select another Song.



Specifying the top of a Song as Point A

Specify Point A before starting playback, then start playback and specify Point B.

Specifying the end of a Song as Point B

Specifying only Point A results in repeat playback between Point A and the Song end (as Point B).

NOTE

You can also specify the repeat range by the following procedure.

- 1 Highlight the measure number using the [^] button, then fast-forward the Song to Point A using the [<|>] buttons.
- 2 Highlight “Set A” using the [v] button, then press the [>] button.
After specifying Point A, the display for specifying Point B is called up.
- 3 Specify Point B in the same way as Point A.

Song Repeat setting

MIDI | Audio

- 4-1. Select the desired Repeat type using the [^]/[v] buttons in the setting display.

Setting display







Default setting: Off

- **Off:**
Disables repeated playback.
- **Single:**
Plays through the selected file repeatedly.
- **All:**
Continuously plays back all Songs within a designated range in order.
- **Random:**
Continuously plays back all Songs within a designated range in random order.

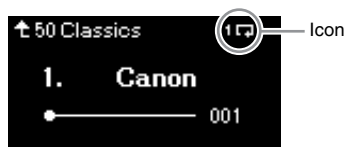
- 4-2. Press the [PLAY/PAUSE] button to start Repeat playback.

Icons corresponding to each Repeat setting are shown on the Song display.



While the Repeat setting is on,  (Single),  (All), or  (Random) is shown in the upper right corner of the Song display.

5. To turn off the Repeat function, press the [PLAY/PAUSE] button again to stop playback, and then select “Off” in step 4-1.

Adjusting the Volume Balance

MIDI | Audio

When a MIDI Song is selected, you can adjust the Volume balance between the Song playback and the sound you are playing on the keyboard, or between the Right and Left parts of the selected Song. When an Audio Song is selected, you can adjust the Audio Song volume.

1. Select the desired Song beforehand. (page 45)
2. Press the [FUNCTION] button repeatedly to call up the “Song” menu display. Select “Volume”, and then press the [>] button.



(When a MIDI Song is selected)
“Song” menu display

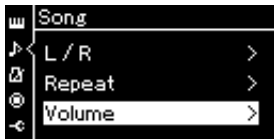

(When an Audio Song is selected)
“Song” menu display

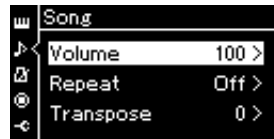

3. When a MIDI Song is selected, select “Song – Keyboard” or “Song L – R” using the [^]/[v] buttons, then press the [>] button to call up the setting display. When an Audio Song is selected, use the [<]/[>] buttons to set the Audio playback volume. After setting the value, go on to step 5.

- **Song – Keyboard**

Adjust the Volume balance between the MIDI Song playback and the sound you are playing on the keyboard.

- **Song L – R**

Adjust the Volume balance between the Right and Left parts of the selected MIDI Song.

(When a MIDI Song is selected)

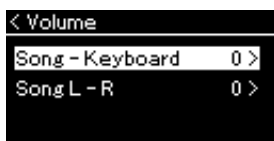

(When an Audio Song is selected)

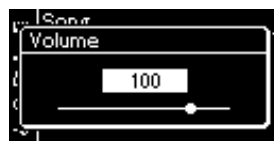

NOTE

Some commercially available music data (MIDI Song) play back at extremely high levels. When using such data, adjust the “Song - Keyboard” setting.

4. Adjust the Volume balance by using the [\leftarrow]/[\rightarrow] buttons.

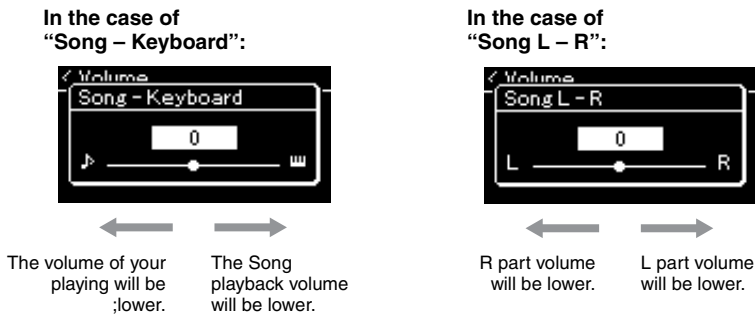

5. Press the [EXIT] button twice to exit from “Song” menu display.

Whenever you select another MIDI Song, the setting for “Song L – R” is restored to its default setting. As for “Song – Keyboard” and Audio Volume, selecting another Song will not reset the value.

Song - Keyboard

Default setting: 0

Setting range: Key+64 – 0 – Song+64

Song L - R

Default setting: 0

Setting range: L+64 – 0 – R+64

NOTE

The selected parameters of “Song – Keyboard” will be maintained (Backup Setting) even when the power is turned off. Make sure not to set the volume levels to minimum. Otherwise the sound of keyboard or songs will not be played. You can change the settings to maintain the selected parameter or not. For details, refer to “Backup Setting” on page 105.

Useful Playback Functions

MIDI

Audio

Starting/pausing playback by using a pedal

You can assign the Song Play/Pause function (equivalent to the [PLAY/PAUSE] button) to the center or the left pedal in the “System” menu. Press the [FUNCTION] button repeatedly to call up the “System” menu display, and then select “Pedal” → “Play/Pause” to make the assignment.

This is convenient for starting or pausing playback when you are performing and can’t take your hands from the keyboard.

Transposing the pitch of a Song

You can shift the pitch of Song playback up or down in semitone intervals. You can change the settings via the “Song” menu display: Press the [FUNCTION] button repeatedly to call up the “Song” menu display → “Transpose” (page 93).

NOTE

The audio sound input from an external device (page 54) cannot be transposed.

Recording Your Performance

This instrument allows you to record your performance in the following two methods.

• MIDI Recording MIDI

With this method, your performances are recorded as an SMF (format 0) MIDI file and saved to the instrument or a USB flash drive. If you want to re-record a specific section or edit parameters such as Voice, use this method. Also you can record your performance to each Track one by one. Since a MIDI Song can be converted to an Audio Song after recording (page 70), you may want to use MIDI recording (with overdubbing and multiple parts) to first create a complex arrangement you would not otherwise be able to play live, then convert it to an Audio Song. This instrument allows you to record approximately 500 KB of data per Song.

• Audio Recording Audio

With this method, your performances are recorded as an Audio file and saved to a USB flash drive. Recording is done without designating the recorded part. Since it is saved in stereo WAV format of normal CD quality resolution (44.1 kHz/16 bit) by default, it can be transmitted to and played on portable music players by using a computer. This instrument allows you to record up to 80 minutes per single recording. Because the audio sound input* from the external device is also recorded, you can record your keyboard performance along with the performance sound of the connected audio device, computer, or smart device, etc. For connection with these devices, refer to page 72.

* Audio sound input (Audio input sound):

Audio data sent to this instrument from the external devices such as a computer or a smart device, etc., when connecting the instrument with the devices via [AUX IN] jack, [USB TO HOST] terminal, wireless LAN, or *Bluetooth*. For example, if the audio data is played back on a smartphone connected with this instrument via *Bluetooth*, the audio data sounds from the internal speaker of this instrument.

For details about the difference between MIDI Songs and Audio Songs, refer to page 44.

Recording Methods

This chapter covers the following four methods. Note that the created data format differs depending on the method, MIDI or Audio.

• Quick MIDI Recording MIDI page 55

This method lets you start recording most quickly. Your performance will be recorded and saved to the “User” category in this instrument’s internal memory.

• MIDI Recording — Independent Tracks MIDI page 57

This lets you record the right, left and extra parts separately. Since you can record the left part while playing back the right, this is useful for recording both parts of a duet. Since you can record up to sixteen parts separately, record the performance of each instrument part one by one and create fully orchestrated compositions.

• MIDI Recording to the USB Flash Drive MIDI page 59

This method is useful when you want to overwrite the already recorded MIDI Song in the USB flash drive or create a New MIDI Song on the USB flash drive.

• Audio Recording to the USB Flash Drive Audio page 61

This method lets you record your performance as Audio data to the USB flash drive connected to the [•↔] (USB TO DEVICE) terminal.

NOTE

You can re-record a specific range of the MIDI Song or change the tempo or the Voice of the recorded Song. For details, refer to “Other Recording Techniques” (page 62).

Quick MIDI Recording

MIDI

This method is the quickest way to start recording.

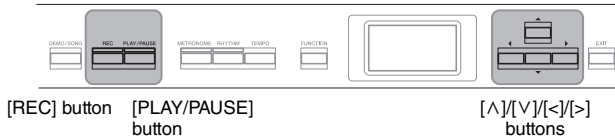

1. Make the necessary settings such as Voice selection and time signature.

Before starting the Recording operation, select a Voice (page 22) for your keyboard performance, turn Dual/Split/Duo on or off as desired, set the tempo and time signature of the Metronome/Rhythm (page 41), then select a Reverb/Chorus/Effect type as desired.

2. Press the [REC] button to enter the Recording mode.

The blank new Song for recording is automatically set.

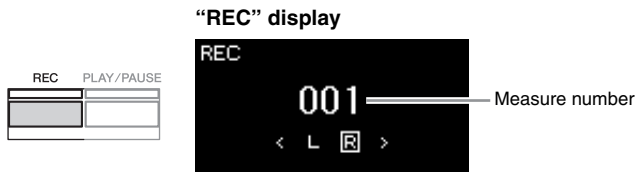

The [PLAY/PAUSE] button will flash at the current tempo. To exit from the Recording mode, press the [REC] button again.

3. Start recording.

Play the keyboard to start recording. When you wish to record an empty section at the start of the Song, press the [PLAY/PAUSE] button to start recording.

“REC” display (during recording)

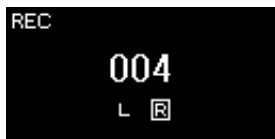

4. After you finish your performance, press the [REC] button again to stop recording.

This operation exits from the Recording mode and calls up the display for saving the recorded performance data.

NOTE

If you want to record the left-hand and right-hand parts individually, refer to “MIDI Recording—independent Tracks” (page 57), since the Recording method here assumes that both the left and right parts are being recorded together.

Using the Metronome/Rhythm

You can use the Metronome/Rhythm while recording. While the Metronome sound cannot be recorded, the Rhythm sound can. Make sure to start enter the Recording mode before starting Rhythm playback, since entering the Recording mode during playback of the Rhythm stops its playback.

NOTE

The “Song – Keyboard” Volume Balance (page 52) will not be recorded.

NOTE

With MIDI recording, the performance will be recorded to Track 1. However, in the Dual/Split/Duo mode, the tracks assigned for recording and the tracks actually used for recording are different. For details refer to “Recording Track Assignment” on page 57.

Mode:

A mode is a status under which you can execute a certain function. In Recording mode, you can record Songs.

NOTE

Pressing and holding the [REC] button for a second will call up the display which lists the Recording Target Songs. In this case, select “New Song” then press the [>] button referring to the table on page 60.

To start recording as soon as a Rhythm starts:

When a Rhythm (page 43) is selected, press the [RHYTHM] button to start Rhythm playback and MIDI recording simultaneously.

5. Select “Save” or “Retry” or “Cancel” for the recorded performance in the “Confirm” display.

- If you want to save the recorded performance, select “Save,” then press the [>] button.
- If you are not satisfied with your performance and want to record again, highlight “Retry” then press the [>] button. Try recording again from step 3.
- If you do not want to save the recorded data, highlight “Cancel” then press the [>] button.



After the Save operation is completed, the display shows “Save Completed” then returns to the Song display. The recorded Song will be named “USERSONGxxx” (xxx: number) and saved in the “User” category.

6. To hear the recorded performance, press the [PLAY/PAUSE] (Play/Pause) button.

NOTICE

The recorded MIDI Song will be lost if you change to another Song or you turn the power off without executing the Save operation.

NOTE

After saving your recorded performance, if you want to record it again, refer to “Re-recording a MIDI Song in parts” (page 62).

Renaming the recorded Song

The recorded Songs are named automatically, but you can rename Songs as you like (page 71).

Data that can be recorded to MIDI Songs	
<p>Data for each Track</p> <ul style="list-style-type: none"> • Note data (your keyboard performance) • Voice selection • Pedal operations (Damper/Soft/Sostenuto) • Reverb Depth • Chorus Depth • Effect Depth • Sound brightness — “Brightness” • Resonance effect setting — “HarmonicContent” • Octave • Volume setting for each Voice — “Volume” • Pan for each Voice • Detune • Touch Sensitivity 	<p>Data commonly for all Tracks</p> <ul style="list-style-type: none"> • Scale • Tempo • Time Signature • Reverb Type • Chorus Type • Effect Type

NOTE

Parameter settings other than Voice and Tempo, such as note data, pedal (Damper/Soft/Sostenuto) data, octave setting and time signature, cannot be changed after recording.

MIDI Recording — Independent Tracks

MIDI

With MIDI Recording, you can create a MIDI Song consisting of 16 tracks by recording your performance to each track one by one. In recording a piano piece, for example, you can record the right-hand part to Track 1 then record the left-hand part to Track 2, allowing you create a complete piece which may be difficult to play live with both hands together. To record a performance with Rhythm playback, for example, record Rhythm playback, then record melodies to Track 1 while listening to the already recorded Rhythm playback. In this way, you can create an entire Song which would otherwise be difficult, or even impossible, to play live.

Example:

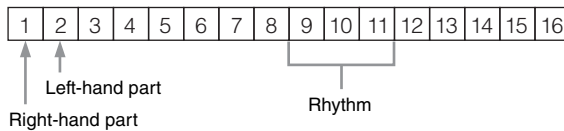

When you want to record a new track of an already recorded MIDI Song:

After step 1 on page 55, select the target MIDI Song (steps 1 – 4 on pages 45 – 46). Press and hold the [REC] button for a second to call up the display which lists the Recording Target Songs, select the 4th item (the selected MIDI Song), press the [>] button, and then go to step 2 on this page.

1. Execute the same operations as in step 1 and step 2 on page 55 to enter the Recording mode with a new blank Song selected.
2. Use the [<]/[>] buttons to select a Recording Track.
Rhythm cannot be added to a recorded Song. When you want to record Rhythm, make sure to record the Rhythm playback first.

When you want to record the right-hand part, highlight “R” (Track 1). When you want to record the left-hand part, highlight “L” (Track 2). Alternately, when you want to record your performance to Tracks 3 – 16, call up the desired one by pressing the [<]/[>] buttons repeatedly. If the Rhythm playback was recorded first before other tracks, it is automatically recorded to one of the Tracks 9 – 11 (or all the three tracks). If this is the case, select the desired track for recording from any except for these tracks.

Track Data Status



Recording Track

 Contains data.

 Contains no data.

NOTE

If you want to record your performance to the USB flash drive or you want to add the recording to the MIDI Song in the USB flash drive, refer to “MIDI Recording to the USB flash drive” (page 59).

NOTE

Because bass accompaniment of the Rhythm sounds only when playing the keyboard, in order to record the bass accompaniment, it is necessary to record keyboard performance with it as well.

Recording Track Assignment

- When recording the Rhythm, you cannot freely select desired tracks. The Rhythm is recorded to Tracks 9 – 11.
- When Dual/Split/Duo is on, only the R1 Voice performance will be recorded to the selected Track, and the R2 Voice performance will be recorded to the Track number which is 6 plus the selected Track, and the L Voice performance of Split/Duo will be recorded to the Track number which is 3 plus the selected Track. Rhythm playback will be recorded to Tracks 9 – 11.

NOTICE

Note that recording your performance to a Track containing data will overwrite the previously recorded data.

3. Start recording.

Play the keyboard to start recording.

When you want to record the Rhythm playback first, press the [RHYTHM] button to start recording.

When you want to record an empty section at the start of the Song, press the [PLAY/PAUSE] button to start recording.

4. After you finish your performance, press the [REC] button to stop recording.

This operation exits from the Recording mode and calls up the display for saving the recorded performance data.

5. If you want to save the recorded performance, press the [>] button to execute the Save operation while “Save” is highlighted.

- If you save the recorded performance, select "Save", then press the [>] button.
- If you are not satisfied with your performance and want to record again, highlight the cursor to “Retry” then press the [>] button. Try recording again from step 3.
- If you do not want to save the recorded data, highlight “Cancel” then press the [>] button.

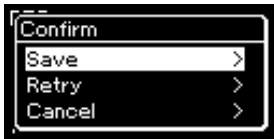

After the Save operation is completed, the display shows “Save Completed” then returns to the Song display. The recorded Song will be named “USERSONGxxx” (xxx: number) and saved in the “User” category.

6. To hear the recorded performance, press the [PLAY/PAUSE] button.

7. To record another Track, enter the Song Recording mode again.

7-1. Press and hold the [REC] (Record) button for a second.

The Recording Target Songs will be listed on the display.

7-2. Use the [V] button to select existing MIDI Song (at the bottom of the list), then press the [>] button.



NOTICE

The recorded MIDI Song will be lost if you change to another Song or you turn the power off without executing the save operation.

NOTE

After saving your recorded performance, if you want to record it again, refer to “Re-recording a MIDI Song in parts” (page 62).

Renaming the recorded Song

The recorded Songs are named automatically, but you can rename Songs as desired (page 71).

You can check whether or not each Track contains recorded data by the indication that appears at the upper right of each Track. For details on the indication, refer to “Track Data Status” on page 57.

8. Record your performance to another track by repeating steps 2 – 6 of this section.

In step 2, select a track which has no recorded data. In step 3, play the keyboard while listening to the already recorded data.

MIDI Recording to the USB Flash Drive

MIDI

These instructions describe how to overwrite an already recorded MIDI Song in the USB flash drive or how to create a New MIDI Song on the USB flash drive.

1. Connect the USB flash drive to the [] (USB TO DEVICE) terminal.
2. Select a MIDI Song as Recording target, then enter the Recording mode.
 - 2-1. If you want to record an additional Track to the already recorded MIDI Song, select the desired MIDI Song in the USB flash drive. If you want to record from scratch, skip this step.
 - 2-2. Press and hold the [REC] button for a second to call up the display which lists the Recording Target Songs.



NOTICE

Note that recording your performance to a Track containing data will overwrite the previously recorded data.

NOTE

To connect a USB flash drive, be sure to read the section “Connecting USB Devices” on page 74.

NOTE

Before starting the Recording operation, check the remaining memory capacity of the USB flash drive. “System” menu: “Utility” → “USB Properties” (page 101).

- 2-3. From the Recording Target Songs, select “New Song (USB)” or the MIDI Song selected in step 2-1 (4th item below) using the [^]/[v] buttons, then press the [>] button to enter the Recording mode.

Recording Target Song	Description
New Song	Select this when you want to record your performance to a blank MIDI Song and save to “User” category in this instrument's internal memory.
New Song (USB)*	Select this when you want to record your performance to a blank MIDI Song and save to the USB flash drive.
New Audio (USB)*	Select this when you want to record your performance to blank audio data and save to the USB flash drive.
xxxxx (MIDI Song selected in step 2-1 above)**	Select this when you want to record additionally to/overwrite the currently selected MIDI Song.

* Can be selected only when the USB flash drive is connected to the [↔] (USB TO DEVICE) terminal.

** Will not be shown when an already recorded MIDI Song is not selected in step 2-1 or when a Preset Song or Protected Song is selected in step 2-1.

3. Execute the Recording operation, then save the recorded performance.

- **When you want to record additionally to the currently selected MIDI Song, or record to a specified track on a blank MIDI Song:**

Execute steps 2 – 8 in “MIDI Recording—Independent Tracks” on page 57.

- **When you want to quick record to a blank MIDI Song:**

Execute steps 3 – 6 in “Quick MIDI Recording” on page 55.

NOTICE

Note that recording your performance to a Track containing data will overwrite the previously recorded data.

NOTE

The time signature and tempo cannot be changed when replacing the part of an existing MIDI Song.

Audio Recording to the USB Flash Drive

Audio

These instructions describe how to record your performance as audio data. Note that an audio file to which your performance is to be recorded can be saved only to a USB flash drive. This is why you should prepare your USB flash drive device before starting the Recording operation.

1. **Connect the USB flash drive to the [•↔] (USB TO DEVICE) terminal.**
2. **Press and hold the [REC] (Record) button for a second to call up the display which lists the Recording Target Songs.**
3. **Use the [^]/[v] buttons to select “New Audio (USB)” then press the [>] button.**
4. **Execute steps 3 – 6 in “Quick MIDI Recording” (page 55).**
Unlike with MIDI Recording, the elapsed time is shown on the display while Audio Recording is being executed.



In the case of Audio recording, the audio input from the external device such as a computer or a smart device (via [AUX IN] jack, [USB TO HOST] terminal, wireless LAN, or *Bluetooth*) is also recorded. For connection with these devices, refer to page 72.

NOTE

To connect a USB flash drive, be sure to read the section “Connecting USB Devices” on page 74.

NOTE

Before starting the Recording operation, check the remaining memory capacity of the USB flash drive. “System” menu: “Utility” → “USB Properties” (page 101).

NOTE

With Audio recording, distorted sound may be produced if the Voice Volume is set to the value higher than the default setting. Make sure to set the Voice Volume to the default value or less before recording from the “Voice” menu display: “Voice Edit” → “Volume” (page 90).

Other Recording Techniques

Re-recording a MIDI Song in parts

MIDI

You can re-record a specific range of the MIDI Song.

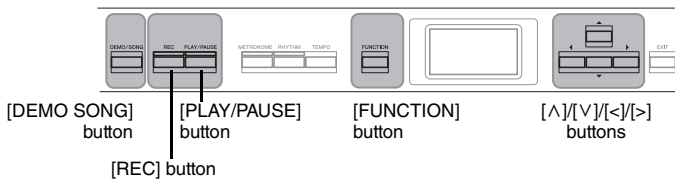

1. Set the parameters which determine how recording starts and stops.

1-1. Press the [FUNCTION] button repeatedly to call up the “Recording” menu display.



1-2. Use the [^]/[V] buttons to select “RecStart,” then select the value which determines how recording starts by using the [>] button.

- **Normal**

The already recorded data will be replaced with the new one as soon as recording starts.

- **KeyOn**

The already recorded data will be maintained until you press a key, and actual recording starts as soon as you press a key.

1-3. Use the [^]/[V] buttons to select “RecEnd,” then select the value which determines how recording stops by using the [>] button.

- **Replace**

The data after the point you stop recording will also be erased.

- **PunchOut**

The data after the point you stop recording will remain.

2. Press the [DEMO/SONG] button to call up the Song List display.

3. Select the desired MIDI Song.

For instructions, refer to page 45.

4. Specify the start point you wish to re-record.

Use the [<]/[>] buttons to move the playback position (measure number) to the desired point. Alternately, press the [PLAY/PAUSE] button to start playback, then press the [PLAY/PAUSE] button again slightly prior to the desired point.

If necessary, select the settings (Voice and other parameters).

Select the desired settings, if you wish to change the previous ones.

5. Press and hold the [REC] button for a second to call up the display which lists the Recording Target Songs, then select the 4th item (Song selected in step 3), then press the [>] button to enter the recording mode.

6. Use the [<]/[>] buttons to select a Track for re-recording.

7. Play the keyboard or press the [PLAY/PAUSE] button to start recording.

8. Press the [REC] button to stop recording.

9. Save the recorded performance by following step 5 on page 56.

10. To hear the recorded performance, press the [PLAY/PAUSE] button.

NOTE

The time signature cannot be changed when replacing the part of an existing Song.

Changing the tempo or the Voice of a previously recorded MIDI Song

MIDI

For MIDI Songs, you can change the tempo and Voice after recording to change a feel or to set a more suitable tempo.

To change the tempo:

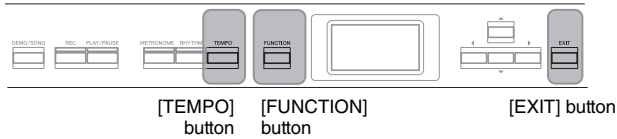

1. **Select the MIDI Song you wish to change.**
For instructions, refer to page 45.
2. **Press the [TEMPO] button to call up the “Tempo” display, then set the desired Tempo.**
For instructions, refer to page 41.
3. **Press the [FUNCTION] button repeatedly to call up the “Song” menu display, then select the highlighted item in each display as illustrated below.**

“Song” menu display

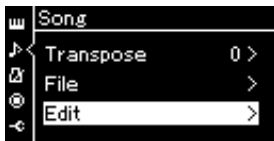

- 3-1. Use the [^]/[v] buttons to select “Edit.”
- 3-2. Press the [>] button to call up the next display.

“Edit” display



- 3-3. Use the [^]/[v] buttons to select “Tempo Change.”
- 3-4. Press the [>] button to call up the next display.

“Tempo Change” display

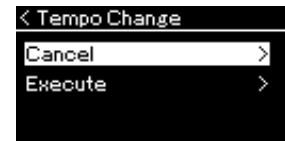

4. **Apply the selected Tempo value to the current MIDI Song data.**

Press the [v] button to highlight “Execute,” then press the [>] button to apply the new Tempo value to the current MIDI Song data.



When this operation is completed, “Completed” is shown on the display, and the “Tempo Change” display will be restored after a while.

5. **Press the [EXIT] button to exit from the “Song” menu display.**

To change the Voice:

1. **Select the MIDI Song you wish to change.**
For instructions, refer to page 45.
2. **Select the desired Voice.**
For instructions, refer to page 22.
3. **Press the [FUNCTION] button repeatedly to call up the “Song” menu display, then select the highlighted item in each display as illustrated below.**

“Song” menu display

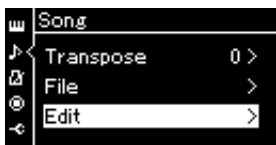

3-1. Use the [^]/[v] buttons to select “Edit.”

3-2. Press the [>] button to call up the next display.

“Edit” display

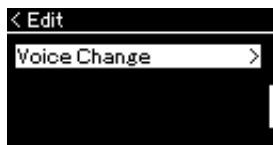

3-3. Use the [^]/[v] buttons to select “Voice Change.”

3-4. Press the [>] button to call up the next display.

“Voice Change” display

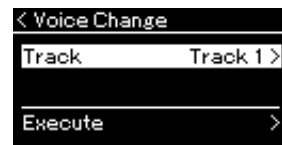

4. **Press the [>] button to call up the setting display, then select the desired Track using the [^]/[v] buttons.**
5. **Apply the Voice selected in step 2 for the Track selected in step 4 to the current MIDI Song data.**

Press the [<] button to return to the “Voice Change” display. Press the [v] button to highlight “Execute,” then press the [>] button to apply the new Voice to the current MIDI Song data.



When this operation is completed, “Completed” is shown on the display, and the “Voice Change” display will be restored after a while.

6. **Press the [EXIT] button to exit from the “Song” menu display.**

Handling Song Files

The “File” menu in the “Song” menu display (page 93) enables you to apply various operations to Song files — Songs you recorded on this instrument or commercially available Songs.

To connect a USB flash drive, be sure to read the section “Precautions when using the [] (USB TO DEVICE) terminal” on page 74.

Operation	File menu	Page
Deleting files	Delete	pages 67, 68
Copying files	*Copy	pages 67, 68
Moving files	*Move	pages 67, 69
Converting a MIDI Song to an Audio Song during playback	*MIDI to Audio	pages 67, 70
Renaming files	Rename	pages 67, 71

File

A file contains a group of data. On this instrument, a Song file includes Song data and a Song name.

Settings marked with a “*” are effective only when a MIDI Song is selected.

Song Types and File Operation Limitations

Song types are indicated as the category name and icon in the Song display. The following chart shows the Song type and restrictions on File operations.

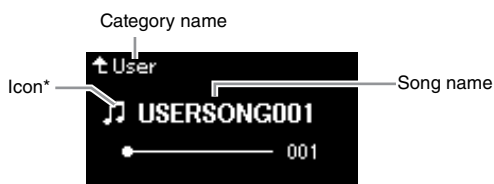







* The icon appears only when you select a Song in the “User” or “USB” category.

Restrictions for protected Songs

Commercially available Song data may be copy protected to prevent illegal copying or accidental erasure.

O: Yes, x: No

Data Location	Category	Song Type	Icon	Deleting files	Renaming files	Copying files	Moving files	Convert a MIDI Song to an Audio Song during playback
	50 Classics	50 classical Preset Songs	–	x	x	x	x	x
	User	Your own recorded Songs (MIDI)		○	○	○	○	○
		MIDI Songs with protect applied		○	○	x	x	x
		MIDI Songs with Yamaha's proprietary protect applied		○	○	x	○	x
USB flash drive device	USB	MIDI Songs		○	○	○	○	○
		Audio Songs		○	○	x	x	x
		MIDI Songs with protect applied		x	x	○	x	x
		MIDI Songs with Yamaha's proprietary protect applied		○	○	x	○	x

* There are two types of Songs: original and edited. Original and edited Songs should be saved in the same folder. If not, playback cannot be done.

Basic Song File Operation

Song files can be handled via the instructions shown below.

1. **Connect the appropriate USB flash drive containing the desired files to the [↔] (USB TO DEVICE) terminal as necessary.**

2. **Select a Song for handling.**

For information on selecting a Song, see page 45.

3. **Call up the File mode.**

3-1. **Press the [FUNCTION] button repeatedly to call up the “Song” menu display. Use the [^]/[v] buttons to select “File” then press the [>] button.**

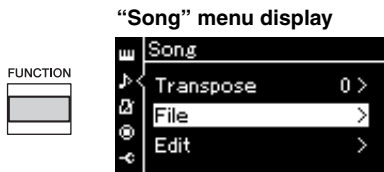

3-2. **Use the [^]/[v] buttons to select the desired operation from “Delete,” “Copy,” “Move,” “MIDI to Audio” or “Rename.”**

For example: Renaming files

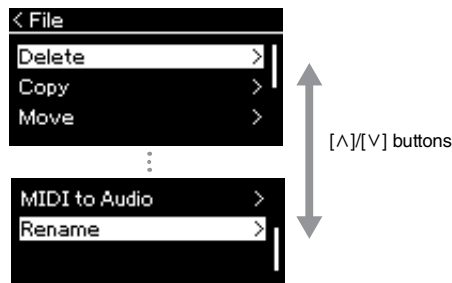

From here, if you wish to close the File mode, press the [EXIT] button once or twice.

4. **Execute the selected operation.**

For specific instructions, refer to the corresponding section.

- **Delete**.....page 68
- **Copy**.....page 68
- **Move**page 69
- **MIDI to Audio**page 70
- **Rename**page 71

During operation, messages (information, confirmation, etc.) may be shown on the display. For explanations and details, refer to “Message List” on page 110.

5. **Press the [EXIT] button to close the File mode.**

NOTICE

Do not disconnect the USB flash drive during file handling or when a USB flash drive is mounted. Doing so may delete all data in the USB flash drive and the instrument.

Deleting Files — Delete

For details about Song types which can be deleted, refer to page 66.

See page 67 for information on basic operations.

The following is a detailed procedure of step 4 on that page.

- 4-1. While “Delete” is highlighted, press the [>] button to call up the setting display.

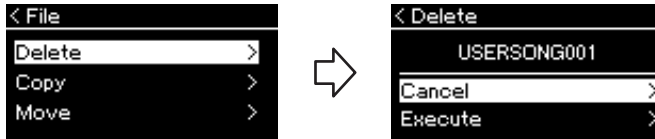

- 4-2. Highlight “Execute” by pressing [v] button, and then press the [>] button.

After the Song is deleted, the display returns to the Song List display.

NOTICE

Do not turn off the power or eject the USB flash drive while “Executing” is shown in the display.

Copying Files — Copy

For details about Song types which can be copied, refer to page 66.

Range of the Copy/Move operation

As for a MIDI Song in the “User” category in the instrument, you can Copy/Move it only to the USER FILES folder on a USB flash drive. Selecting a MIDI Song from “User” for copying/moving automatically specifies the USER FILES folder as the destination.

As for a MIDI Song in a USB flash drive, you can Copy/Move it to the “User” category in the instrument.

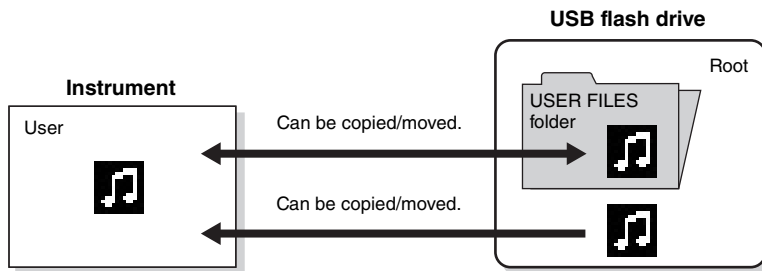

See page 67 for information on basic operations.

The following is a detailed procedure of step 4 on that page.

USER FILES folder

If the USB flash drive device plugged into the instrument contains no USER FILES folder, one will be created automatically when you format or record a Song to that device. The recorded Song will then be saved in that folder.

NOTE

Please note that the copy features are intended for your personal use only.

NOTE

Folders cannot be copied.

Root:

The highest level of a hierarchical structure. This indicates an area which does not belong to a folder.

- 4-1. While “Copy” is highlighted, press the [>] button to call up the setting display.

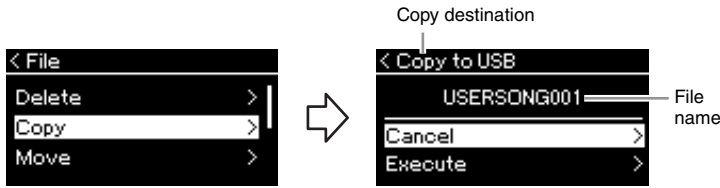

- 4-2. Highlight “Execute” by pressing [V] button, then press the [>] button.

The selected Song will be copied to the destination with the same name as the copy source file.

Copy destination:

“USB” will be shown when the copy destination is the USB flash drive or “User” when the instrument is the copy destination. A file copied to the USB flash drive is stored to the USER FILES folder on it.

NOTE

A message appears when a Song with the same name already exists in the copy destination. Select “Overwrite” when you want to overwrite the selected Song, or “Cancel” to cancel by using the [^]/[V] buttons, and then press the [>] button.

NOTICE

Overwrite operations erase any existing data of the copy destination file and overwrite with data of the copy source file.

NOTICE

Do not turn off the power or eject the USB flash drive while “Executing” is shown in the display.

Moving Files — Move

For details about Song types which can be moved, refer to page 66. See page 67 for information on basic operations.

The following is a detailed procedure of step 4 on that page.

- 4-1. While “Move” is highlighted, press the [>] button to call up the setting display.

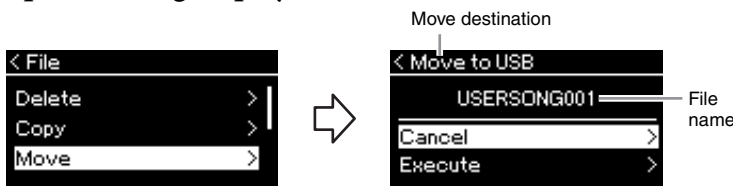

- 4-2. Highlight “Execute” by pressing the [V] button, then press the [>] button.

The selected Song will be moved to the destination and the display returns to the Song list display.

Move destination

“USB” will be shown when the move destination is the USB flash drive or “User” when the instrument is the move destination. A file moved to the USB flash drive is stored to the USER FILES folder on it.

NOTE

A message appears when a Song with same name already exists in the move destination. Select “Overwrite” when you want to overwrite the selected Song, or “Cancel” to cancel by using the [^]/[V] buttons, then press the [>] button.

NOTICE

Overwrite operations erase any existing data of the move destination file and overwrite with data of the move source file.

NOTICE

Do not turn off the power or eject the USB flash drive while “Executing” is shown in the display.

Converting a MIDI Song to an Audio Song during Playback — MIDI to Audio

A MIDI Song in the User memory of the instrument or on a USB flash drive can be converted to an Audio Song. Since an Audio Song can be saved only to a USB flash drive, you should start conversion only after connecting the USB flash drive to the instrument. For information about which Song types can be converted, refer to page 66.

See page 67 for information on basic operations.

The following is a detailed procedure of step 4 on that page.

4-1. While “MIDI to Audio” is highlighted, press the [>] button to call up the setting display.

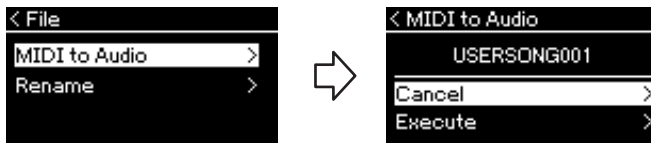

4-2. Highlight “Execute” by pressing the [√] button, then press the [>] button.

This operation starts playback and conversion from MIDI to Audio. This is basically the same as that of Audio Song Recording, which allows you to record your keyboard performance and other audio, such as that from [AUX IN]. After you convert the Song, a message “Convert completed” will be shown and the display returns to Song List display.

The Audio Song converted from a MIDI Song is saved with the same name as the MIDI Song. The icon displayed to the left of the Song name on the instrument display is changed, and the Song file extension on the computer is changed to “.wav”.

NOTE

- After conversion, the MIDI Song remains in the original data location.
- If you start conversion before connecting the USB flash drive to the instrument, an error message appears on the display.

NOTICE

Do not turn off the power or disconnect the USB flash drive during the conversion. Otherwise the data will be lost.

NOTE

A message appears when a Song with same name already exists in the copy destination. Select “Overwrite” when you want to overwrite the selected Song by using the [^]/[√] buttons, then press the [>] button.

NOTE

To cancel this operation, press the [EXIT] button during the conversion. When the operation is canceled, the converted Audio Song will not be saved.

Renaming Files — Rename

For details about Song types which can be renamed, refer to page 66.

See page 67 for information on basic operations.

The following is a detailed procedure of step 4 on that page.

- 4-1. While “Rename” is highlighted, press the [>] button to call up the setting display.

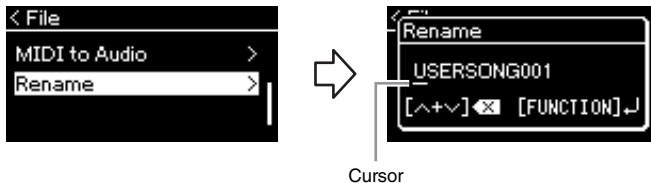

- 4-2. Assign a name to the Song.

Use the [<]/[>] buttons to move the highlight (underline).

Use the [^]/[v] buttons to change the character at the current cursor position. Pressing both buttons simultaneously will delete the character at the current cursor position.

A Song name can contain up to 46 characters. Characters which extend beyond the display capacity and are not visible can be viewed by moving the highlight by using the [<]/[>] buttons.

- 4-3. Press the [FUNCTION] button.

After the Song is renamed, the display returns to Song List display where the renamed Song can be selected.

NOTE

For information about the character types available for the Song name, refer to “Language” on page 102.

NOTICE

Do not turn off the power or eject the USB flash drive while “Executing” is shown in the display.

Connections

Connectors

For information about location of these connectors, refer to “Panel Controls and Terminals” on page 12.

Front Panel

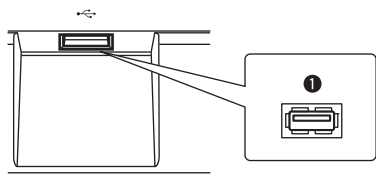

Rear Panel

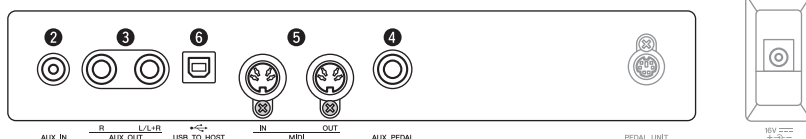

1 [] (USB TO DEVICE) terminal

This terminal allows connection to USB flash drive or a smart device, such as an iPhone/iPad, using the USB wireless LAN adaptor. For details, refer to “Connecting USB Devices” on page 74 and “Connecting to a Computer/Smart Device” on page 75.

2 [AUX IN] jack

You can connect the headphone jack of a portable audio player to the instrument’s [AUX IN] jack, letting you hear the sound of that audio player through the built-in speakers of the instrument.

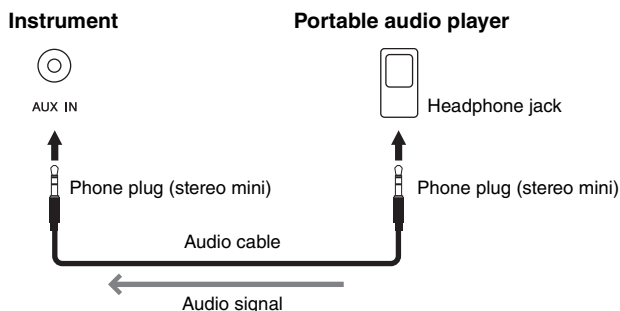



CAUTION

Before connecting the instrument to other electronic components, turn off the power of all the components. Also, before turning any components on or off, make sure to set all volume levels to minimum (0). Otherwise, damage to the components, electrical shock, or even permanent hearing loss may occur.

NOTE

For details on [PEDAL UNIT] terminal and [DC IN] jack, refer to “Panel Controls and Terminals” on page 13.

NOTE

There are two different types of USB terminals on the instrument: [] (USB TO DEVICE) and [] (USB TO HOST). Take care not to confuse the two terminals and the corresponding cable connectors. Be careful to connect the proper plug in the proper direction.

NOTICE

When this instrument’s [AUX IN] jack is connected to an external device, first turn on the power to the external device, and then to the instrument to avoid possible damage. Reverse this order when you turn the power off.

NOTE

The instrument’s [MASTER VOLUME] setting affects the input signal from the [AUX IN] jack.

NOTE

Use audio cables and adaptor plugs having no (zero) resistance.

3 AUX OUT [R] [L/L+R] jacks

These jacks let you connect this instrument to external powered speaker systems, for playing in larger venues at higher volumes.

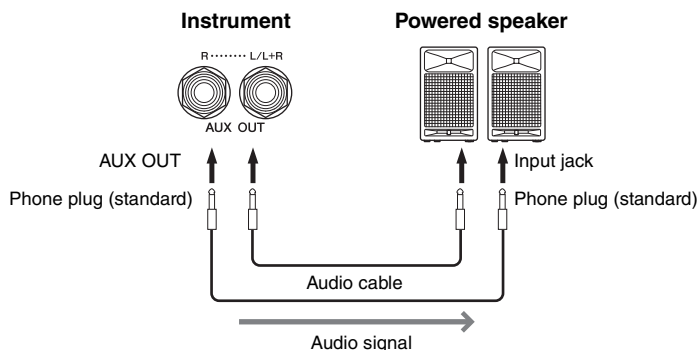

The [MASTER VOLUME] setting of this instrument affects the sound that is output from the AUX OUT jacks. When the AUX OUT jacks of this instrument are connected to an external speaker and you want to turn off the speaker sound of the instrument, switch the “speaker” parameter to off via the “System” menu: “Utility” → “Speaker” (page 101).

4 [AUX PEDAL] jack

An included FC4A foot switch, or a separately sold FC3A foot pedal or FC5 foot switch can be connected to this jack.

For details on the functions assigned to the pedals, refer to “Pedal Function List” (page 92). To select the function that will be controlled, use the “Aux Assign” (page 99) in the “System” menu display.

5 MIDI [IN], [OUT] terminals

These terminals are used to connect external MIDI devices, such as a synthesizer or a sequencer. For details, refer to “Connecting External MIDI Devices” on page 80.

6 [USB TO HOST] terminal

This terminal allows connection to a computer or a smart device, such as an iPhone/iPad. For details, refer to “Connecting to a Computer/Smart Device” on page 75.

NOTE

Use only the [L/L+R] jack for connection with a monaural device.

NOTICE

- To avoid possible damage, first turn on the power to the instrument, then to the external device. When turning off the power, first turn off the power to the external device, then to the instrument. Since this instrument’s power may automatically be turned off due to the Auto Power Off function (page 15), turn off the power to the external device, or disable Auto Power Off when you do not intend to operate the instrument.
- Do not route the output from the AUX OUT jacks to the [AUX IN] jack. If you make this connection, the signal input at the [AUX IN] jack is output from the AUX OUT jacks. These connections could result in a feedback loop that will make normal performance impossible, and may even damage the equipment.

NOTE

Use audio cables and adaptor plugs having no (zero) resistance.

NOTE

When you are monitoring the sound output via the AUX OUT jacks from headphones connected to the instrument, we recommend that you set the Binaural Sampling and Stereophonic Optimizer functions to off. For details, refer to page 17.

NOTE

- Connect or disconnect the pedal when the power of this instrument is turned off.
- Do not press the footswitch/foot pedal while turning the power on. Doing this changes the recognized polarity of the footswitch, resulting in reversed footswitch operation.

Connecting USB Devices ([↔]) (USB TO DEVICE) Terminal

You can connect a USB flash drive or a USB wireless LAN adaptor (sold separately) to the [↔] (USB TO DEVICE) terminal. You can save data you've created on the instrument to the USB flash drive (pages 66, 105), or you can connect the instrument to a smart device such as an iPad via wireless LAN (page 75).

Precautions when using the USB TO DEVICE terminal

This instrument features a built-in USB TO DEVICE terminal. When connecting a USB device to the terminal, be sure to handle the USB device with care. Follow the important precautions below.

NOTE

For more information about the handling of USB devices, refer to the owner's manual of the USB device.

■ Compatible USB devices

- USB flash drive
- USB hub
- USB wireless LAN adaptor (UD-WL01) (sold separately; may not be available in some areas)

Other USB devices such as a computer keyboard or mouse cannot be used.

The instrument does not necessarily support all commercially available USB devices. Yamaha cannot guarantee operation of USB devices that you purchase. Before purchasing a USB device for use with this instrument, please visit the following web page:

<https://download.yamaha.com/>

After selecting your country and clicking on "Documents and Data" from the "Support" page, select the desired Language and Product Category, and then enter the model name into the search box.

Although USB devices 2.0 to 3.0 can be used on this instrument, the amount of time for saving to or loading from the USB device may differ depending on the type of data or the status of the instrument. USB 1.1 devices cannot be used on this instrument.

NOTICE

The rating of the USB TO DEVICE terminal is a maximum of 5V/500mA. Do not connect USB devices having a rating above this, since this can cause damage to the instrument itself.

■ Connecting a USB device

When connecting a USB device to the USB TO DEVICE terminal, make sure that the connector on the device is appropriate and that it is connected in the proper direction.

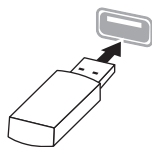

NOTICE

- Avoid connecting or disconnecting the USB device during playback/recording and file management operations (such as Save, Copy, Delete and Format), or when accessing the USB device. Failure to observe this may result in "freezing" of the operation of the instrument or corruption of the USB device and the data.

- When connecting then disconnecting the USB device (and vice versa), make sure to wait a few seconds between the two operations.

NOTE

If you intend to connect two or three devices at the same time to a terminal, you should use a bus-powered USB hub. Only one USB hub can be used. If an error message appears while using the USB hub, disconnect the hub from the instrument, then turn on the power of the instrument and re-connect the USB hub.

NOTICE

Do not use an extension cable when connecting a USB device.

Using USB Flash Drives

By connecting the instrument to a USB flash drive, you can save data you've created to the connected device, as well as read data from the connected USB flash drive.

■ Number of USB flash drives that can be used

Only one USB storage device can be connected to the USB TO DEVICE terminal. (If necessary, use a USB hub. The number of USB storage devices that can be used simultaneously with musical instruments even when a USB hub is used is one.)

■ Formatting a USB flash drive

You should format the USB flash drive only with this instrument (page 101). A USB flash drive formatted on another device may not operate properly.

NOTICE

The format operation overwrites any previously existing data. Make sure that the USB flash drive you are formatting does not contain important data. Proceed with caution, especially when connecting multiple USB flash drive.

■ To protect your data (write-protect)

To prevent important data from being inadvertently erased, apply the write-protect provided with each USB flash drive. If you are saving data to the USB flash drive, make sure to disable write-protect.

■ Turning off the instrument

When turning off the instrument, make sure that the instrument is NOT accessing the USB flash drive by playback/recording or file management (such as during Save, Copy, Delete and Format operations). Failure to do so may corrupt the USB flash drive and the data.

Connecting to a Computer/Smart Device ([USB TO HOST] Terminal, [↔] (USB TO DEVICE) Terminal, MIDI Terminals)

By connecting this instrument to a computer or a smart device, such as an iPhone, iPad, etc., you can take advantage of convenient functions and get more enjoyment out of it. For details on what you can do by using the connections, refer to page 81.

Connection example

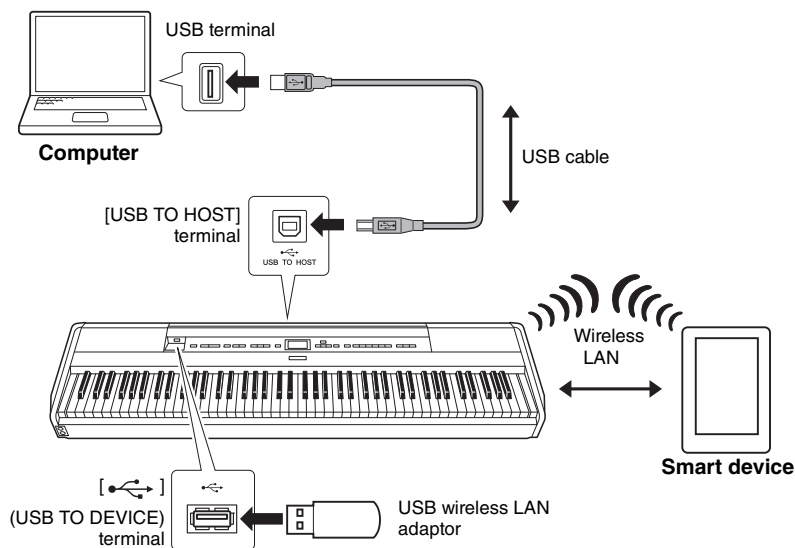

For more information, refer to “Computer-related Operations” and “Smart Device Connection Manual” on the website (page 9).

If you use the smart device app “Smart Pianist” (page 84) with the instrument, the connection wizard on the app helps you to connect the instrument to your smart device properly.

NOTICE

- Use an AB type USB cable of less than 3 meters. USB 3.0 cables cannot be used.
- If you are using a DAW (digital audio workstation) application with this instrument, set the Audio Loop Back function (page 85) to off. Otherwise, a loud sound may occur, depending on the settings of the computer or the application software.
- Do not place your computer or smart device in an unstable position. Doing so may cause the device to fall and result in damage.

NOTE

- When using a USB cable to connect the instrument to your computer or smart device, make the connection directly without passing through a USB hub.
- Before using the [↔] (USB TO DEVICE) terminal, be sure to read “Connecting USB Devices” on page 74.
- For information on setting up your sequencer software, refer to the owner’s manual of the relevant software.
- When transmitting or receiving audio signals by using a computer running Windows, the Yamaha Steinberg USB Driver should be installed to the computer. For details, refer to the “Computer-related Operations” on the website.
- When you use the instrument along with an app on your smart device, we recommend that you set your device to not emit radio waves (for example, by setting “Airplane Mode” to “On”).
- The instrument will begin transmission a short time after the computer or smart device is connected.

Connecting via Wireless LAN (with the UD-WL01)

* The USB wireless LAN adaptor UD-WL01 (sold separately) may not be available depending on your area.

When connecting a smart device by using the USB wireless LAN adaptor, start wireless connection according to the instructions in the “Smart Device Connection Manual” on the website, then make sure to set up the instrument appropriately, using the following instructions: “Displaying the Wireless LAN Networks and Connecting to a Network,” “Automatic Setup by WPS,” “Manual Setup” or “Connecting by the Accesspoint Mode.” Refer to pages 76 – 79 in this Owner’s Manual for the required operations on this instrument.

■ Displaying the Wireless LAN Networks and connecting to a Network

Make sure to connect the USB wireless LAN adaptor (sold separately) to the [↔] (USB TO DEVICE) terminal, otherwise the displays for setup below will not be shown.

1. Press the [FUNCTION] button repeatedly to call up the “System” menu display, then select the highlighted item in each display as illustrated below.

“System” menu display

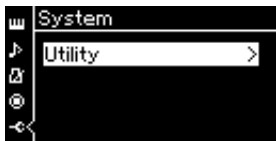

- 1-1. Use the [^]/[v] buttons to select “Utility.”
- 1-2. Press the [>] button to call up the next display.

“Utility” display

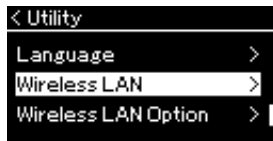

- 1-3. Use the [^]/[v] buttons to select “Wireless LAN.”
- 1-4. Press the [>] button to call up the next display.

“Wireless LAN” display

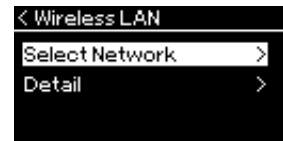

- 1-5. Use the [^]/[v] buttons to select “Select Network.”

2. Press the [>] button to call up the network list.

For a network with a lock icon , you need to enter the proper password.

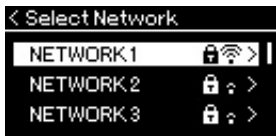

NOTE

If the menus shown in the “Wireless LAN” display are different from the instruction here, the instrument is in the Accesspoint mode. Set the Wireless LAN Mode parameter to “Infrastructure Mode” by following the step 1 on page 79.

NOTE

If no signal from the access point is received, the access point cannot be listed. Also, closed access points cannot be listed.

3. Connect the instrument to the Network.

3-1. Select the desired network, then press the [>] button.

The name of the selected network will be fully shown in the display, letting you confirm this is the network you want to use.

3-2. Press the [>] button.

- **For a network without a lock icon:**

Connecting starts.

- **For a network with a lock icon:**

You need to enter the proper password. For details on how to enter characters, refer to the “Renaming files” on page 71. After entering the password, press the [FUNCTION] button to finalize the setting. This operation starts connecting automatically.

When connection is done successfully, “Completed” is shown in the display, and returns to the “Select Network” display.

4. Connect the smart device to the access point.

For instructions on the setup for the smart device, refer to the “Smart Device Connection Manual” on the website (page 9).

■ Automatic Setup by WPS

Make sure to connect the USB wireless LAN adaptor (sold separately) to the [] (USB TO DEVICE) terminal, otherwise the displays for setup will not be shown.

If your access point supports WPS, you can easily connect the instrument to access point by WPS, without making settings, such as password input, etc. Press the WPS button on the USB wireless LAN adaptor more than 3 seconds, and press the WPS button on your access point within two minutes.

When connection is done successfully, “Completed” is shown in the display, and the Voice display will be shown.

Finally, connect the smart device to the access point. For instructions on the setup for the smart device, refer to the “Smart Device Connection Manual” on the website (page 9).

NOTE

WPS setup is not available while the instrument is in the following modes or conditions:

- While a Song or a Demo Song is playing back or being paused temporarily, or while the instrument is in the Song Recording mode.
- When Wireless LAN mode is set to “Accesspoint Mode” in the “System” menu.

■ Manual Setup

Make sure to connect the USB wireless LAN adaptor (sold separately) to the [↔] (USB TO DEVICE) terminal, otherwise the displays for setup will not be shown.

1. To call up the network list, perform steps 1 – 2 in the “Displaying the Wireless LAN Networks and connecting to a Network” (page 76).

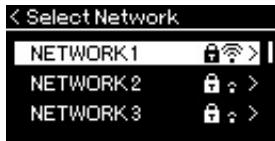

2. Select “Other” at the bottom of the network list, then press the [>] button.
3. Set the SSID, Security and Password to the same as the settings on the access point.

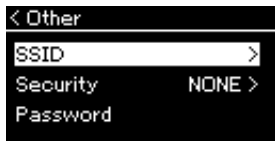

- 3-1. Select the “SSID” then press the [>] button to call up the display for SSID input, then enter the SSID.

For details on how to enter the characters, refer to “Renaming files” on page 71. After entering the SSID, press the [FUNCTION] button to finalize the setting. Operation returns to the “Other” display.

- 3-2. Select “Security” then press the [>] button to call up the Security list. Select the security then return to the “Other” display by pressing the [<] button.

- 3-3. Select “Password,” then set the password in the same way as SSID.

4. Select “Connect” at the bottom of the display shown in step 3, then press the [>] button to start connecting.

When connection is done successfully, “Completed” is shown in the display, and returns to the “Select Network” display.

5. Connect the smart device to the access point.

For instructions on the setup for the smart device, refer to the “Smart Device Connection Manual” on the website (page 9).

NOTE

The password cannot be set when you select “none” for the security setting.

■ Connecting by the Accesspoint Mode

Make sure to connect the USB wireless LAN adaptor (sold separately) to the [↔] (USB TO DEVICE) terminal, otherwise the displays for setup will not be shown.

NOTE

This cannot be used to connect to the internet or another wireless LAN device.

1. Switch the instrument to the “Accesspoint Mode.”

Press the [FUNCTION] button repeatedly to call up the “System” menu display, then select the highlighted item in each display as illustrated below.

“System” menu display

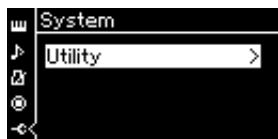

- 1-1. Use the [^]/[V] buttons to select “Utility.”
- 1-2. Press the [>] button to call up the next display.

“Utility” display

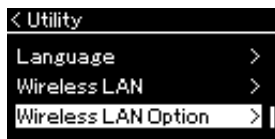

- 1-3. Use the [^]/[V] buttons to select “Wireless LAN Option.”
- 1-4. Press the [>] button to call up the next display.

“Wireless LAN Option” display

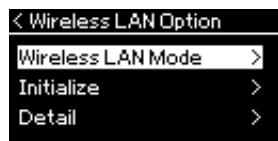

- 1-5. Use the [^]/[V] buttons to select “Wireless LAN Mode.”
- 1-6. Press the [>] button to call up the next display.

“Wireless LAN Mode” display

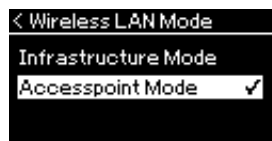

- 1-7. Use the [^]/[V] buttons to select “Accesspoint Mode.”

When mode change is done successfully, “Completed” is shown in the display, operation returns to the “Wireless LAN Mode” display.

2. Set SSID, Security, Password and Channel.

- 2-1. From the “System” menu display, select the highlighted item in each display as illustrated below.

“System” menu display

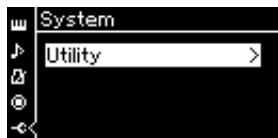

“Utility” display

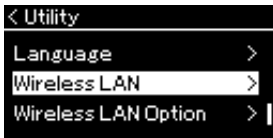

“Wireless LAN” display



- 2-2. Set the SSID, Security, Password and Channel.

Select and enter each value/setting in the same way as in step 3 in “Manual Setup.” For the setting range for each item, refer to the table on page 104.

3. Save the setting.

Select “Save” at the bottom of the “Wireless LAN” display, then press the [>] button to start saving.

When saving is done successfully, “Completed” is shown in the display, and operation returns to the “Utility” display.

4. Connect the smart device to the instrument (as an access point).

For instructions on the setup for the smart device, refer to the “Smart Device Connection Manual” on the website (page 9).

Connecting External MIDI Devices (MIDI Terminals)

The sophisticated MIDI functions give you powerful tools to expand your music performance and creation possibilities. Use the MIDI terminals and standard MIDI cables to connect external MIDI devices (keyboard, sequencer, etc.)

- **MIDI [IN]** Receives MIDI messages from another MIDI device.
- **MIDI [OUT]** Transmits MIDI messages generated on this instrument to another MIDI device.

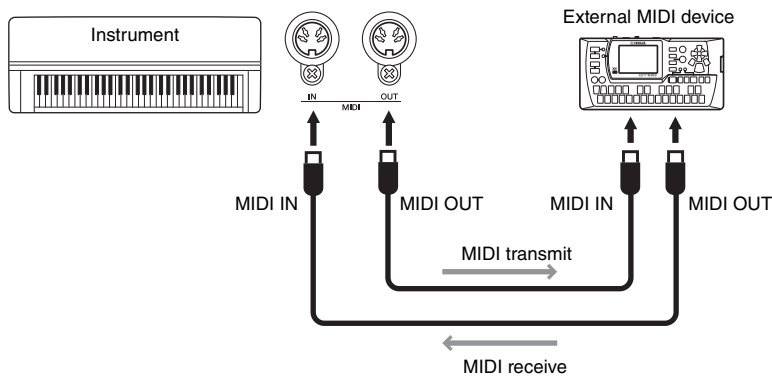

CAUTION
 Before connecting the instrument to other MIDI devices, turn off the power of all the components.

NOTE
 Since MIDI data that can be transmitted or received varies depending on the type of MIDI device, check the MIDI Data Format to find out what MIDI data and commands your devices can transmit or receive. The MIDI Data Format is contained in the “MIDI Reference” downloadable from the Yamaha website (page 9).

Effective Use of a Computer or Smart Device with the Instrument

Connecting this instrument to a computer or a smart device, gives you the following possibility.

What you can do by connecting to a computer/smart device:

- Listening to the audio data in the smart device through this instrument (*Bluetooth* Audio function, page 81)
- Using a smart device app (page 84)
- Transmitting and receiving audio data (USB Audio Interface function, page 85)
- Transmitting and receiving MIDI data (page 80)
- Transferring MIDI Songs (extension: .mid, SMF Format 0 or 1) or backup files (page 105)

Listening to Audio Data from a Smart Device through this Instrument (*Bluetooth* Audio Function)

Bluetooth capability

Depending on the country in which you purchased the product, the instrument may not have *Bluetooth* capability. If the *Bluetooth* logo is printed on the front panel, this means that the product is equipped with *Bluetooth* functionality.

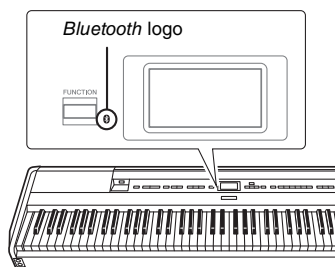

Before using the *Bluetooth* function, be sure to read “About *Bluetooth*” on page 8.

You can input the sound of the audio data saved in a *Bluetooth*-equipped device such as a smart phone, digital audio player to this instrument and listen to it through the built-in speakers of the instrument. Also, you can record the input audio data as an Audio Song (page 61).

You can set whether the Audio sound input to the instrument by using this function is output to a computer or smart device or not, along with the performance played on the instrument. For details, refer to “Audio Loop Back On/Off” on page 85.

NOTE

For details on transmitting/receiving MIDI data or transferring MIDI Songs/backup files to a computer, refer to the “Computer-related Operations” on the website.

NOTE

In this manual, “*Bluetooth*-equipped device” refers to a device that can transmit audio data saved in it to the instrument using the *Bluetooth* function, via wireless communication. For proper operation, the device must be compatible with A2DP (Advanced Audio Distribution Profile). The *Bluetooth* Audio function is explained here by using a smart device as an example of such *Bluetooth*-equipped devices.

Pairing with Smart Devices

If you wish to connect your smart device to the instrument via *Bluetooth*, the smart device needs to be paired with the instrument first. Once the smart device has been paired with this instrument, there is no need to perform pairing again.

1. Hold down the [FUNCTION] button for 3 seconds.

The pop-up window will appear which indicates that the instrument is standing by for pairing.

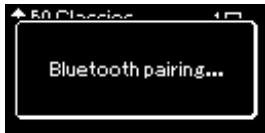

To cancel the pairing, press the [EXIT] button.

2. On the smart device, set the *Bluetooth* function to on and select “P-515” from the connection list.

For details, refer to the smart device owner’s manual.

After pairing is completed, the pop-up window will close, and the *Bluetooth* icon appears on the Voice display and Song display.

Voice display



3. Play back audio data on the smart device to confirm that the built-in speakers of the instrument can output the audio sound.

When you turn on the instrument the next time, the last-connected smart device will be connected to this instrument automatically, if the *Bluetooth* function of the smart device and the instrument is set to on. If it is not connected automatically, select the model name of the instrument from the connection list on the smart device.

Pairing

“Pairing” means to register *Bluetooth*-equipped smart devices on this instrument, and establish the mutual recognition for wireless communication between the two.

NOTICE

When you force-quit the instrument after pairing, the pairing data is lost. After restarting the instrument, execute the steps 1 and 2 again for pairing.

NOTE

Only one smart device can be connected to this instrument at a time (although up to 8 smart devices can be paired to this instrument). When pairing with the 9th smart device has succeeded, pairing data for the device with the oldest connection date will be deleted.

NOTE

When the *Bluetooth* function of this instrument is set to “Off,” standby for pairing with the instrument is not enabled when holding the [FUNCTION] button for 3 seconds. In this case, set *Bluetooth* to “On” (page 83), and then start pairing.

NOTE

Make sure to complete the settings on the smart device within 5 minutes.

NOTE

If you are required to enter a passkey, enter the numerals “0000.”

NOTE

You can adjust the volume of the sound input via *Bluetooth* by the [MASTER VOLUME] slider. To adjust the volume balance between your keyboard performance and the input sound via *Bluetooth*, adjust the volume on the smart device.

NOTE

You can start pairing from the “System” menu display: Press the [FUNCTION] button repeatedly to call up the “System” menu display → “Bluetooth” → “Pairing,” and then press the [>] button.

Switching the *Bluetooth* Function On/Off

By default, the *Bluetooth* function will be on right after turning the instrument's power on, however you can set the function to off.

1. Press the [FUNCTION] button repeatedly to call up the "System" menu display, then select the highlighted item in each display as illustrated below.

"System" menu display

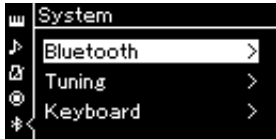

1-1. Confirm that "Bluetooth" is selected.

1-2. Press the [>] button to call up the next display.

"Bluetooth" display

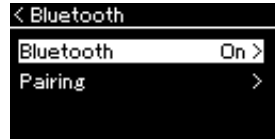

1-3. Confirm that "Bluetooth" is selected.

2. Press the [>] button to switch on/off.

To exit from the "System" menu display, press the [EXIT] button.

Using a Smart Device App

By using the compatible smart device app, you can get more enjoyment out of this instrument.

For information about the compatible apps and smart devices, access the web page of the respective apps on the following page:

<https://www.yamaha.com/kbdapps/>

Smart device app “Smart Pianist”

The smart device app “Smart Pianist” (available as a free download) lets you select Voices and make Metronome settings intuitively, and allows you to display the notation, depending on the selected data. For details, access the “Smart Pianist” page on the website above.

For instructions on connecting the instrument to a smart device, the connection wizard of the “Smart Pianist” will guide you according to the operating condition and environment.

To start the connection wizard, tap “” (Menu) located at the upper left on the “Smart Pianist” screen to open the Menu, and then tap “Instrument” → “Start Connection Wizard.”

For information on connecting manually without using the connection wizard of the “Smart Pianist” app, refer to the “Smart Device Connection Manual” on the website (page 9).

NOTICE

Activating the “Smart Pianist” app while the instrument is connected to the smart device overwrites the settings on the instrument by that of “Smart Pianist.” Save your important setup data as a backup file to a USB flash drive or computer (page 105).

NOTE

When using the “Smart Pianist” app, you cannot use any buttons on the instrument other than the [EXIT] button. Control the instrument by using “Smart Pianist.” Pressing the [EXIT] button on the instrument disconnects the instrument from the “Smart Pianist” app, and enables you to control the instrument by using its buttons.

Transmitting/Receiving Audio Data (USB Audio Interface function)

By connecting a computer or a smart device to the [USB TO HOST] terminal via a USB cable, digital audio data can be transmitted/received. This USB Audio Interface function provides the following advantages:

- **Playing back audio data with high sound quality**

This gives you direct, clear sound in which the sound quality has less noise and deterioration than that from the [AUX IN] jack.

- **Recording performance on the instrument as audio data by using a recording software or a music production software**

The recorded audio data can be played back on the computer or smart device.

Audio Loop Back On/Off

This allows you to set whether audio sound input (page 54) from the connected computer or smart device is output to a computer or a smart device or not along with the performance played on the instrument. To output the audio input sound, set the Audio Loop Back to “On.”

For example, if you want to record the audio input sound as well as the sound played on the instrument by using the computer or the smart device, set this to “On.” If you intend to record only the sound played on the instrument by using the computer or the smart device, set this to “Off.”

To make the setting, press the [FUNCTION] button repeatedly to call up the “System” menu display: “Utility” → “Audio Loop Back” (page 102).

Audio EQ On/Off

This allows you to set whether the optimum EQ (or Equalizer) settings are provided for audio sound input (page 54) from the connected computer or smart device or not.

This function also affects the audio input sound that is output to a computer, etc. along with the performance played on the instrument.

Audio sound input from the connected computer, etc. will be the optimum sound using this function.

We recommend that you set this function off when outputting audio input sound to a computer, etc.

To make the setting, press the [FUNCTION] button repeatedly to call up the “System” menu display: “Utility” → “Audio EQ” (page 102).

NOTE

- The Audio Loop Back function also affects the audio input sound when using the *Bluetooth* Audio function (page 81) or wireless LAN connection (page 75).
- The volume of the audio input sound can be adjusted from a computer or smart device.
- The playback sound of an Audio Song (page 44) is also output to a computer or smart device when this is set to “On,” while the sound is not output when this is set to “Off.”
- With Audio Recording (page 61), the audio input sound from the connected computer or smart device is recorded when this is set to “On,” while the sound is not recorded when this is set to “Off.”

Performing Live

Your instrument features a number of convenient functions for use when setting it up on stage in order to perform live. In order to provide a practical description of the connections and settings required in this type of situation.

Stage setup and signal flow

The sound from your instrument will be sent to a PA mixer, then the mixed sound is amplified and sent to the front-of-house speakers so that the audience can hear it. Monitor speakers may be placed on the floor in front of the musicians so that they can more clearly hear their own sound and that of the other instruments.

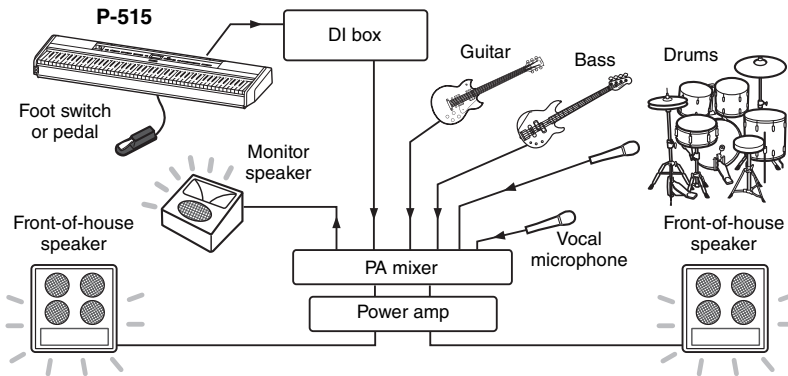

NOTICE
Please read the following before setting up.

- Ensure that the instrument is turned off before making any connections.
- Make sure to check with the PA operator when connecting or disconnecting cables or turning on/off. Failure to do so may damage to the PA system.

NOTE

- When playing the piano sound of this instrument with an external powered speaker, and while monitoring the sound output from this instrument on connected headphones, we recommend that you set the "Binaural Sampling" or "Stereo-Optimizing" functions to "OFF" (page 17).
- If only one of the DI box channels is available for use with your instrument, connect it to the AUX OUT [L/L+R] jack using a standard mono audio cable. In this configuration, your left and right signals will be mixed and output from the instrument in mono.
- If DI boxes are not being used, connect the AUX OUT [R] and [L/L+R] jacks to the input jacks on the PA mixer or an on-stage sub-mixer.

■ Connect your footswitch/foot pedal, or pedal unit.

For details on using footswitch/ foot pedal, or pedal unit, refer to page 18 and 19. For the function that can be assigned to each pedal, refer to page 92.

■ Connect the instrument's output to the PA mixer.

In order to be heard, your instrument will need to be connected to the PA mixer's inputs. Normally, this connection is made via a DI box (direct box) located onstage. Connect the AUX OUT [R] and [L/L+R] jacks on the instrument's rear panel to the DI box inputs using commercially available standard mono audio cables.

- 1 Set the [MASTER VOLUME] slider to the MIN position.
- 2 Check with the PA operator whether you can connect the instrument to the PA mixer or not.
- 3 Connect the instrument as the following illustration.

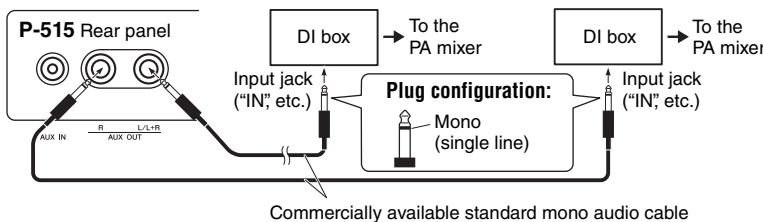

Your instrument should now be fully connected. The next step will be to balance your performance sounds.

Sound setup

Once all of the instruments and microphones have been connected, the PA operator will ask each musician in turn to play his or her instrument. You should get ready as follows.

■ Turn on your instrument.

Set the [MASTER VOLUME] slider to the MIN position. Check with the PA operator whether you can turn on the instrument, then press the [⏻] (Standby/On) switch.

■ Check your settings.

Once turned on, ensure that your instrument is set up as follows.

- Tuned to match the other instruments (Master tuning, page 35).
- Auto Power-Off function disabled (page 15).
- Footswitch or foot pedal is operating correctly as an assigned function (page 99).
- Reverb is turned off (page 28).
- Turn off the speaker sound of your instrument (page 101) as necessary.

■ Determine the optimum levels.

When asked by the PA operator to output a sound, play the digital piano as you would when performing and determine the best settings for the following.

- Volume when you are playing accompaniment
- Volume when you are playing loudest, such as during a keyboard solo
- Volume of each Voice to be used

Roughly speaking, the [MASTER VOLUME] slider should be set between 5 and 7 for playing accompaniment and to 8 or 9 when you need to play louder. If set too high, your sound may become distorted; if too low, any background noise will be more noticeable.

Turn on the Sound Boost function if you are finding it difficult to make your instrument heard within the overall mix. Choose from three different Sound Boost types (page 37).

The Master EQ function may help in making the optimum sound for performing live.

■ Balance the overall sound of the band.

After the levels of the various instruments have been set, the PA operator will have everyone play together in order to balance the overall sound of the band. At this time, you should listen to the nearest monitor speaker and ensure that you can hear everything you need to in order to play well. If, for example, you cannot hear your own sound, the singer, or another instrument well enough, ask the PA operator to raise the corresponding level in your monitor's mix.

This completes the setup process. You should now be ready to play live.

Lock the front panel to prevent mistakes.

Your instrument's Panel Lock function allows you to temporarily disable front panel buttons to prevent them being operated unintentionally while performing. When performing live, disable the Auto Power Off function (page 15). For details on this function, refer to page 40.

Detailed Settings

Pressing the [FUNCTION] button gives you access to a variety of important settings for Voices, Song playback, Metronome, Song recording and the entire system of this instrument.

Basic Operations





1. As necessary, make the Voice settings or select a Song.

- If you want to edit Voice-related parameters (by calling up the “Voice” menu), select a Voice. If you want to edit parameters related to the R1/R2/L Voices, such as volume balance, turn on Dual/Split/Duo, then select the desired Voices.
- If you want to set Song playback parameters, such as Repeat, select a Song.
- If you want to edit your recorded MIDI Song data (by calling up Edit in the “Song” menu), select the recorded MIDI Song.

2. Press the [FUNCTION] button several times to select the desired menu.

Pressing the [FUNCTION] button repeatedly will call up the following menu displays in order, according to the vertical menu at the left of the display.



-  “Voice” menu (page 89)
-  “Song” menu (page 93)
-  “Metronome/Rhythm” menu (page 96)
-  “Recording” menu (page 97)
-  “System” menu (page 98)

3. Use the [^]/[v]/[<]/[>] buttons to select the desired parameter.

While referring as needed to the parameter list on each page listed in step 2, use the [^]/[v] buttons to navigate through the display vertically and use the [<]/[>] buttons to navigate through display horizontally.

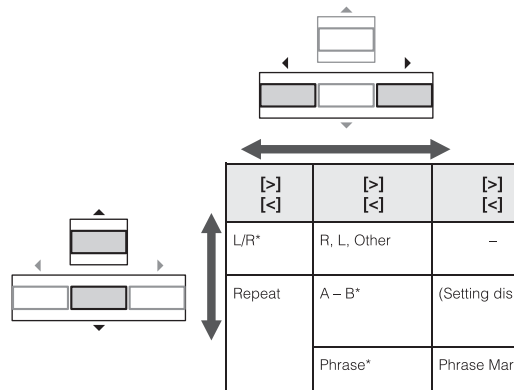

4. On the display called up in step 3, select a value or execute the operation.

Most displays allow you to select a value by simply using the [^]/[v] buttons, although some, such as Edit in the “Song” menu and Backup in the “System” menu, let you execute an operation.

If a pop-up window is shown, set the value with the [<]/[>] buttons, then exit from the window using the [EXIT] button.

Also, when the selected parameter provides only two options (on and off, for example), simply pressing the [>] button will alternate the value between the two options.



5. To exit from the menu display, press the [EXIT] button.



Voice Menu

This menu lets you edit or set various parameters related to keyboard performance, such as Voice parameters. By turning on Dual/Split/Duo, you can make the settings for each Voice or each Voice combination. While playing the keyboard and hearing the sound, change a parameter value to find your desired sound. Note that you should turn on Dual/Split/Duo before calling up the “Voice” menu display.

NOTE

Parameters with * are shown only when Dual/Split/Duo is on.

To call up the desired parameter:					
Turn on Dual, Split or Duo as necessary, select Voices as necessary, press the [FUNCTION] button several times to select “Voice” menu, then use the [^]/[v]/[<]/[>] buttons to select the desired parameter.					
[>] [<]	[>] [<]	[>] [<]	Description	Default setting	Setting range
Transpose (page 34)	(Pop-up window)	–	Shifts the pitch of the entire keyboard up or down in semitone intervals to facilitate playing in difficult key signatures, and to let you easily match the pitch of the keyboard to the range of a singer or other instruments.	0	-12 (-1 octave) – 0 (normal pitch) – +12 (+1 octave)
Piano Setting (pages 25 – 26)	Lid Position	(Setting display)	Determines how much the Lid is opened.	Full	Full, Half, Close
	VRM	–	Turns the VRM effect on/off. For the information about the function of VRM, refer to page 27. For details about the Piano Voices compatible with VRM, refer to the “Preset Voice List” on page 107.	On	On, Off
	Damper Res.	(Setting display)	Determines the depth of the string resonance effect which is applied when the damper pedal is pressed. This is available only when VRM is on.	5	0 – 10
	String Res.	(Setting display)	Determines the depth of the string resonance effect which is applied when a note on the keyboard is pressed. This is available only when VRM is on.	5	0 – 10
	Aliquot Res.	(Setting display)	Adjusts the sympathetic vibrations of Aliquot. This is available only when VRM is on. For details, refer to “What is Aliquot?” (page 27).	5	0 – 10
	Body Res.	(Setting display)	Adjusts the resonance of the soundboard, the sides, the frame, and the grand piano itself. This is available only when VRM is on.	5	0 – 10
	Key Off Sample	(Setting display)	Determines the volume of the key-off sound (the subtle sound that occurs when you release a key) which is available only for some Voices. For Voices to which this effect is applied, refer to the Voice List (page 107).	5	0 – 10
Reverb (page 28)	(Setting display)	–	Determines the Reverb type which is applied to all the entire sound including the keyboard performance, Song playback and MIDI data input from an external MIDI device.	Differs depending on the Voice or Voice combination.	Refer to the Reverb Type List (page 92)
Chorus (page 28)	(Setting display)	–	Determines the Chorus type which is applied to all the entire sound including the keyboard performance, Song playback and MIDI data input from an external MIDI device.	Differs depending on the Voice or Voice combination.	Refer to the Chorus Type List (page 92)

To call up the desired parameter:					
Turn on Dual, Split or Duo as necessary, select Voices as necessary, press the [FUNCTION] button several times to select "Voice" menu, then use the [^]/[v]/[<]/[>] buttons to select the desired parameter.					
[>] [<]	[>] [<]	[>] [<]	Description	Default setting	Setting range
Voice Edit	(Voice names)*	Octave	Shifts the pitch of the keyboard up and down in octave steps. This parameter can be set for each Voices when Dual/Split/Duo is on.	Differs depending on the Voice or Voice combination.	-2 (two octaves lower) – 0 (no pitch shift) – +2 (two octaves higher)
		Volume	Adjusts the volume for each of the R1/R2/L Voices. This lets you adjust the balance between the R1/R2/L Voices when Dual/Split/Duo is on.	Differs depending on the Voice or Voice combination.	0 – 127
		Reverb Depth (page 28)	Adjusts the Reverb depth for each of the R1/R2/L Voices. This lets you adjust the balance between the R1/R2/L Voices when Dual/Split/Duo is on. The "0" setting will produce no effect. NOTE When a VRM Voice is used for several parts simultaneously, unexpected sounds may result since the Reverb depth for a part which has priority will become the common setting for the parts. During Song playback, setting for a Song part is used (priority order: Ch. 1, Ch. 2...Ch. 16), while the setting for a keyboard part is used when Song playback is stopped (priority order: R1, L and R2 Voices).	Differs depending on the Voice or Voice combination.	0 – 127
		Chorus Depth (page 28)	Adjusts the Chorus depth for each of the R1/R2/L Voices. This lets you adjust the balance between the R1/R2/L Voices when Dual/Split/Duo is on. The "0" setting will produce no effect. NOTE When a VRM Voice is used for several parts simultaneously, unexpected sounds may result since the Chorus depth for a part which has priority will become the common setting for the parts. During Song playback, setting for a Song part is used (priority order: Ch. 1, Ch. 2...Ch. 16), while the setting for a keyboard part is used when Song playback is stopped (priority order: R1, L and R2 Voices).	Differs depending on the Voice or Voice combination.	0 – 127
		Effect (page 28)	In addition Reverb and Chorus, another Effect can be applied to the R1/R2/L Voices of the keyboard independently. Note that this Effect type can be selected for up to two Voices.	Differs depending on the Voice or Voice combination.	Refer to the Effect Type List (page 92).
		Rotary Speed	Available only for the Voice of which the Effect Type is set to "Rotary." This parameter determines the rotation speed of the Rotary Speaker effect.	Differs depending on the Voice or Voice combination.	Fast, Slow
		VibeRotor	Available only for the Voice of which the Effect Type is set to "VibeRotor." This parameter turns on or off the VibeRotor effect.	Differs depending on the Voice or Voice combination.	On, Off
		VibeRotor Speed	Available only for the Voice of which the Effect Type is set to "VibeRotor." This parameter determines the speed of the Vibraphone vibrato effect.	Differs depending on the Voice or Voice combination.	1 – 10
		Effect Depth	Adjusts the Effect depth for each of the R1/R2/L Voices. Note that some Effect types do not allow you to adjust the depth.	Differs depending on the Voice or Voice combination.	1 – 127
		Pan	Adjusts the stereo pan position for each of the R1/R2/L Voices.	Differs depending on the Voice or Voice combination.	L64 (leftmost) – C (center) – R63 (rightmost)

To call up the desired parameter:					
Turn on Dual, Split or Duo as necessary, select Voices as necessary, press the [FUNCTION] button several times to select "Voice" menu, then use the [^]/[v]/[<]/[>] buttons to select the desired parameter.					
[>] [<]	[>] [<]	[>] [<]	Description	Default setting	Setting range
Voice Edit	(Voice names)*	Harmonic Cont	Produces a distinctive "peaky" tone by raising the Resonance value of the Filter. This parameter can be set for each of the R1/R2/L Voices when Dual/Split/Duo is on. NOTE Harmonic content may have little audible effect or not be applied to some Voices.	Differs depending on the Voice or Voice combination.	-64 – +63
		Brightness	Adjusts the brightness of the R1/R2/L Voices independently.	Differs depending on the Voice or Voice combination.	-64 – +63
		Touch Sens.	Determines the degree to which the volume level changes in response to your touch on the keyboard (how hard you play). Since the volume level of some Voices such as Harpsichord and Organ do not change regardless of how you play the keyboard, the default setting for these Voices is 127.	Differs depending on the Voice or Voice combination.	0 (softest) – 64 (largest changes in the level) – 127 (which produces the loudest volume regardless of how you play the keyboard)
		RPedal	Turns the Right pedal function on or off for each of the R1/R2/L Voices. This parameter is useful when you want to ensure, for example, that the pedal function affects the right-hand performance but does not affect the left-hand performance.	Differs depending on the Voice or Voice combination.	On, Off
		CPedal	Turns the Center pedal function on or off for each of the R1/R2/L Voices. This parameter is useful when you want to ensure, for example, that the pedal function affects the right-hand performance but does not affect the left-hand performance.	Differs depending on the Voice or Voice combination.	On, Off
		LPedal	Turns the Left pedal function on or off for each of the R1/R2/L Voices. This parameter is useful when you want to ensure, for example, that the pedal function affects the right-hand performance but does not affect the left-hand performance.	Differs depending on the Voice or Voice combination.	On, Off
Pedal Assign (When using the separately sold pedal unit, page 19)	Right	(Setting display)	Assigns one of various functions (other than the original one) to the Right pedal.	Sustain (Cont.)	Refer to the Pedal Function List (page 92).
	Center	(Setting display)	Assigns one of various functions (other than the original one) to the Center pedal.	Sostenuto	Refer to the Pedal Function List (page 92).
	Left	(Setting display)	Assigns one of various functions (other than the original one) to the Left pedal.	Rotary Speed (Jazz Organ), Vibe Rotor (Vibraphone), Soft (other Voices)	Refer to the Pedal Function List (page 92).
Balance*	Volume R2 – R1*	(Pop-up window)	Adjusts the volume balance between R1 and R2 Voices when Dual is on. After adjusting this with the [<]/[>] buttons, press the [EXIT] button to exit from the pop-up window.	Differs depending on the Voice or Voice combination.	R2+10 – 0 – R1+10
	Volume L – R*	(Pop-up window)	Adjusts the volume balance between the left and right keyboard sections when Split/Duo is on. After adjusting via the [<]/[>] buttons, press the [EXIT] button to exit from the pop-up window.	Differs depending on the Voice or Voice combination.	L+10 – 0 – R+10
	Detune*	(Pop-up window)	Detunes the R1 Voice and R2 Voice in Dual mode to create a thicker sound. On the display, move the slider rightward via the [>] button will raise the R1 Voice pitch and lower the R2 Voice pitch, and vice versa. After adjusting this, press the [EXIT] button to exit from the pop-up window.	Differs depending on the Voice or Voice combination.	R2+20 – 0 – R1+20

■ Reverb Type List

Off	No effect
Recital Hall	Simulates clear reverberation in a mid-sized hall suitable for piano recital.
Concert Hall	Simulates brilliant reverberation in a large hall for public orchestra performances.
Chamber	Simulates the elegant reverberation in a small room suitable for chamber music.
Cathedral	Simulates the solemn reverberation in a high-ceiling stone-made cathedral.
Club	Simulates the lively reverberation in a jazz club or a small bar.
Plate	Simulates the bright sound of vintage reverb equipment used in recording studios.

■ Chorus Type List

Off	No effect
Chorus	Adds a rich, spacious sound.
Celeste	Adds swell and a spacious sound.
Flanger	Adds swell effects similar to the sound of an ascending or descending jet plane.

■ Effect Type List

Off	No effect
DelayLCR	Delay applied at left, center, and right positions.
DelayLR	Delay applied at left and right positions.
Echo	Echo-like delay
CrossDelay	Left and right delays cross each other in alternation.
Symphonic	Adds a rich and deep acoustic effect.
Rotary	Adds the vibrato effect of a rotary speaker.
Tremolo	The volume level changes in rapid cycles.
VibeRotor	The vibrato effect of a vibraphone.
AutoPan	The sound pans left to right and back and forth.
Phaser	The phase changes periodically, swelling the sound.
AutoWah	The center frequency of the wah filter changes periodically.
Distortion	Distorts the sound.

■ Pedal Function List

* These functions can be used when the included footswitch, or the sold separately foot pedal/footswitch is connected to the [AUX PEDAL] terminal, or the sold separately pedal unit is connected to the [PEDAL UNIT] terminal.

Function	Description	Available pedal (O: Can be assigned, X: Cannot)		
		Left pedal	Center pedal	Right pedal and pedal connected to the [AUX PEDAL] jack
Sustain (Switch)	A function that sustains the notes you play while pressing the pedal, even after releasing your fingers from the keyboard	O	O	O
Sustain (Continuous) *	A function that varies the sustain length depending on how far the pedal is pressed (default setting)	X	X	O
Sostenuto	Sostenuto (page 19)	O	O	O
Soft	Soft (page 19)	O	O	O
PitchBend Up*	A function that smoothly raises the pitch	X	X	O
PitchBend Down*	A function that smoothly lowers the pitch	X	X	O
Rotary Speed**	Changes the rotational speed of the Jazz Organ rotary speaker (switches between fast and slow each time you press the pedal)	O	O	O
VibeRotor**	Switches the vibraphone vibrato on/off (switches on/off each time you press the pedal)	O	O	O

When you want to assign a function indicated by * to the pedal connected to the [AUX PEDAL] jack, you should use a separately sold foot pedal (page 73). For other functions, you should use the included footswitch (page 73).

The functions marked with ** are assigned to the Left pedal automatically when you select the Jazz Organ Voice or Vibraphone Voice.

Song Menu

This menu lets you set various parameters related to Song playback and edit the Song data with a single touch.

NOTE

- The parameters marked with * will be available only when a MIDI Song is selected. These parameters are not shown when an Audio Song is selected.
- The parameters marked with ** will be available only when an Audio Song is selected.
- When using the “Edit” menu, select a MIDI Song other than the preset Song.
- Execute is a function that edits or changes the current Song data. Note that pressing the [>] button will actually change the Song data.
- The content of the “Song” menu differs depending on the type of Song currently selected (MIDI/Audio).

To call up the desired parameter: Select a Song as necessary, press the [FUNCTION] button several times to select “Song” menu, then use the [^]/[v]/[<]/[>] buttons to select the desired parameter.					
[>] [<]	[>] [<]	[>] [<]	Description	Default setting	Setting range
L/R* (page 48)	R, L, Other	–	Turns on (Play) or off (Mute) each of the Song tracks. For details, refer to page 48.	On	On, Off
Repeat (page 49)	A – B*	(Setting display)	Lets you play back a specified range (from Point A to B) of the current Song repeatedly. For instructions, refer to page 49.	Off	On, Off
	Phrase*	Phrase Mark	This parameter is available only when a MIDI Song containing the Phrase Mark. By specifying a Phrase number here, you can play back the current Song from the mark point, or to play back the corresponding phrase repeatedly. If you start Song playback with a Phrase set to “On,” the countdown starts, followed by repeated playback of the specified phrase or phrases until you press the [PLAY/PAUSE] button.	000	000 – the last phrase number of the Song
		Repeat			Off
Volume (page 52)	Song – Keyboard*	(Pop-up window)	Adjusts the volume balance between the Song playback sound and keyboard performance.	0	Key+64 – 0 – Song+64
	Song L – R*	(Pop-up window)	Adjusts the volume balance between the right-hand part left-hand parts of Song playback.	0	L+64 – 0 – R+64
		(Pop-up window)**	Adjusts the Audio volume.	100	0 – 127
Transpose (page 53)	(Setting display)	–	Shifts the pitch of Song playback up or down in semitone intervals. For example, if you set this parameter to “5,” a Song created in C major will be played back in F major. NOTE The Transpose setting will not affect the audio signals, such as those input from the [AUX IN] jack. NOTE MIDI Song playback data will be transmitted with the transposed note numbers while MIDI note numbers received from an external MIDI device or computer will not be affected by the Transpose setting. NOTE Applying transpose to an Audio Song may change its tonal characteristics.	0	-12 (-1 octave) – 0 (normal pitch) – +12 (+1 octave)
File	Delete (page 68)	Cancel	Deletes a specific Song. For details about Song types which can be deleted, refer to page 66.	–	–
		Execute		–	–
	Copy* (page 68)	Cancel	Copies a specific MIDI Song then saves it to a different location. For details about Song types which can be copied, refer to page 66.	–	–
		Execute		–	–

To call up the desired parameter: Select a Song as necessary, press the [FUNCTION] button several times to select "Song" menu, then use the [^]/[v]/[<]/[>] buttons to select the desired parameter.						
[>] [<]	[>] [<]	[>] [<]	Description	Default setting	Setting range	
File	Move* (page 69)	Cancel	Moves a MIDI Song to a different location. For details about Song types which can be moved, refer to page 66.	–	–	
		Execute		–	–	
	MIDI to Audio* (page 70)	Cancel	Converts a MIDI Song to an Audio file. For details about Song types which can be converted, refer to page 66.	–	–	
		Execute		–	–	
	Rename (page 71)	(Setting display)	Edits a Song name. For details about Song types which can be renamed, refer to page 66.	–	–	
	Edit*	Quantize	Quantize	The Quantize function allows you to align all the notes in the current MIDI Song to the correct timing, such as 8th note or 16th note. 1. Set the Quantize value to the smallest notes in the MIDI Song. 2. Set the Strength value which determines how strongly the notes will be quantized. 3. Move the highlight to "Execute" then press the [>] button to actually change the MIDI Song data.	1/16	Refer to "Quantize setting range." (page 95)
Strength			100%		0% – 100% Refer to "Strength setting range." (page 95)	
Execute			–		–	
Track Delete		Track	Deletes a specific track data of the current MIDI Song. 1. Select the desired track to be deleted. 2. Move the highlight to "Execute," then press the [>] button to actually delete the specified track data.	Track 1	Track 1 – Track 16	
		Execute		–	–	
Tempo Change		Cancel	Changes the tempo value of the current MIDI Song as data. Before calling up the "Song" menu display, set the desired Tempo value for changing. Move the highlight to "Execute," then press the [>] button to actually change the Tempo value as MIDI Song data.	Differs depending on the Song		
		Execute		–	–	
Voice Change		Track	Changes the Voice of a specific track in the current MIDI Song to the current Voice as data. 1. Select a track of which the Voice will be changed. 2. Move the highlight to "Execute," then press the [>] button to actually change the Voice as MIDI Song data.	Track 1	Track 1 – Track 16	
		Execute		–	–	
Others*		Quick Play	–	This parameter enables you to specify whether a Song that starts from the middle of a bar, or a Song with a silence prior to the first note, should be played from the first note or from the top of the bar (rest or blank). This parameter is useful for a MIDI Song that starts with a short one-or two-beat pick-up or lead-in.	On	On, Off
		Track Listen	Track	This lets you play back only the selected Track to listen to its contents. To do this, select a Track, move the highlight to "Start," then press and hold the [>] button to start playback from the first note. Playback continues while holding the [>] button.	Track 1	Track 1 – Track 16
			Start			
Play Track	–	This parameter enables you to specify the tracks for playing back on this instrument. When "1&2" is selected, only tracks 1 and 2 will be played back, while tracks 3 to 16 will be transmitted via MIDI. When "All" is selected, all tracks will be played back on this instrument.	All	All, 1&2		

NOTE

Tempo of Song playback can be set on the display called up by pressing the [TEMPO] button. For instructions, refer to page 47.

■ Quantize Supplementary

Quantize setting range

- 1/4..... ♩ quarter note
- 1/6..... ♩₃ quarter note triplet
- 1/8..... ♪ eighth note
- 1/12..... ♪₃ eighth note triplet
- 1/16..... ♪ sixteenth note
- 1/24..... ♪₃ sixteenth note triplet
- 1/32..... ♪ thirty-second note
- 1/8+1/12..... ♪+♪₃ eighth note + eighth note triplet*
- 1/16+1/12..... ♪+♪₃ sixteenth note + eighth note triplet*
- 1/16+1/24..... ♪+♪₃ sixteenth note + sixteenth triplet*

The three Quantize settings marked with asterisks (*) are exceptionally convenient, since they allow you to quantize two different note values at the same time. For example, when the straight eighth notes and eighth notes triplet are contained in the same part, if you quantize by straight eighth notes, all notes in the part are quantized to straight eighth notes—completely eliminating any triplet feel. However, if you use the eighth note + eighth note triplet setting, both the straight and triplet notes will be quantized correctly.

Strength setting range

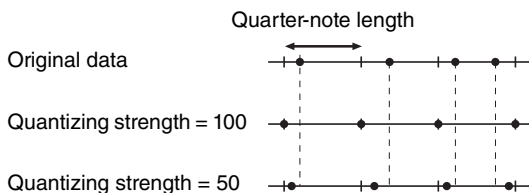

Metronome/Rhythm Menu

This menu lets you set the volume and tempo indication format of the Metronome (page 41) or Rhythm (page 43). In addition, you can set the bell sound of the Metronome to play back at the first beat and adjust parameters related to Rhythm playback variation.

To call up the desired parameter: Press the [FUNCTION] button several times to select "Metronome/Rhythm" menu, then use the [^]/[v] buttons to select the desired parameter.					
[>] [<]	[>] [<]	[>] [<]	Description	Default setting	Setting range
Time Signature	(Setting display)	–	Determines the time signature of the metronome. When you select or playback MIDI Songs, this will automatically be changed to the time signature of the selected songs.	4/4	2/2, 1/4, 2/4, 3/4, 4/4, 5/4, 6/4, 7/4, 3/8, 6/8, 7/8, 9/8, 12/8
Volume	(Pop-up window)	–	Determines the volume of the Metronome or Rhythm. You can adjust the volume balance between the keyboard performance and Metronome/Rhythm playback.	82	0 – 127
BPM	–	–	Determines whether the note type of the tempo indication is affected by the Metronome Time Signature (page 42) or not (crotchet). When "Time Sig." is selected, the denominator of the Time Signature is shown as the note type of the tempo indication. (The dotted quarter note is shown as the note type of the tempo indication only when the Time Signature is set to "6/8," "9/8," or "12/8.")	Time Sig.	Time Sig., Crotchet
Bell	–	–	Determines whether or not the bell sound is played back at the first beat of the specified Time Signature.	Off	On, Off
Intro	–	–	Determines whether the Intro is played back or not before the Rhythm pattern is started. NOTE During Song playback, the Intro cannot be played back even if you start the Rhythm with this parameter set to "On."	On	On, Off
Ending	–	–	Determines whether the Ending is played back or not before the Rhythm pattern is stopped.	On	On, Off
SyncStart	–	–	When this is set to "On," you can start Rhythm playback also by pressing any note on the keyboard. When you want to use this function, follow the instructions below: 1. Set this function to on. 2. Press the [RHYTHM] button to enter the Synchro start standby mode. The [RHYTHM] button flashes. 3. Press any key to start with the rhythm.	Off	On, Off
Bass	–	–	Determines whether the accompaniment Bass sound is added to the Rhythm pattern or not.	On	On, Off

■ Setting the Tempo

Tempo of Metronome/Rhythm can be set on the display called up by pressing the [TEMPO] button. For details on setting the Tempo for the Metronome or Rhythm, refer to page 41.

Recording Menu

This menu lets you make detailed settings related to MIDI Recording (page 54).

NOTE

The settings here will not affect Audio Recording.

To call up the desired parameter: Press the [FUNCTION] button several times to select "Recording" menu, then use the [^]/[v] buttons to select the desired parameter.					
[>] [<]	[>] [<]	[>] [<]	Description	Default setting	Setting range
RecStart	–	–	This parameter, which is used when you overwrite the already recorded MIDI Song, determines when the actual MIDI Recording starts after you execute the Recording Start operation. When set to "Normal," actual recording will start as soon as you execute the Recording Start operation. When set to "KeyOn," actual recording starts as soon as you press any key after you execute the Recording Start operation.	Normal	Normal, KeyOn
RecEnd	–	–	This parameter, which is used when you overwrite the already recorded MIDI Song, determines whether the existing data after the point at which you stop recording will be erased or not.	Replace	Replace, PunchOut
RecRhythm	–	–	Determines whether or not Rhythm playback will be recorded during MIDI Recording.	On	On, Off

/ System Menu

This menu lets you make the overall settings applied to the entire instrument.

Bluetooth compatibility is indicated by the following icons. (For details on *Bluetooth* compatibility, see page 8.)

 : models equipped with *Bluetooth*

 : models not equipped with *Bluetooth*

NOTE

Parameters marked with * are available only if the instrument is equipped with *Bluetooth* functionality.





To call up the desired parameter:					
Press the [FUNCTION] button several times to select "System" menu, then use the [^]/[v]/[<]/[>] buttons to select the desired parameter.					
[>] [<]	[>] [<]	[>] [<]	Description	Default setting	Setting range
Bluetooth* (pages 81 – 83)	Bluetooth	(Setting display)	Switches the <i>Bluetooth</i> function on/off (page 83).	On	On, Off
	Pairing	(Setting display)	For registering (pairing) the <i>Bluetooth</i> device (page 81).	–	–
Tuning	Master Tune (page 35)	(Pop-up window)	Fine tunes the pitch of the entire instrument. This function is useful when you play this instrument along with other instruments or CD music.	A3 = 440.0 Hz	A3 = 414.8 Hz – 466.8 Hz (approx. 0.2 Hz steps)
	Scale Tune	(Setting display)	Modern acoustic pianos are tuned almost exclusively in equal temperament, which divides one octave into twelve equal intervals. Likewise, this digital piano employs equal temperament, but it can be changed at the touch of a button to play in historical temperaments used in the 16th to 19th centuries.	Equal Temperament	Refer to the "Scale Tune List" below.
	Base Note	(Setting display)	Determines the base note for the Scale selected above. When the base note is changed, the pitch of the keyboard is transposed, yet maintains the original pitch relationship between the notes. This setting is necessary when Scale Tune is set to something other than "Equal Temperament." NOTE When Scale Tune is set to "Equal Temperament," "---" is shown on the display and this parameter cannot be edited.	C	C, C#, D, Eb, E, F, F#, G, Ab, A, Bb, B

■ Scale Tune List (Temperament List)

Equal Temperament	One octave is divided into twelve equal intervals. Currently most popular piano tuning scale.
PureMajor/PureMinor	Based on natural overtones, three major chords using these scales produce a beautiful, pure sound.
Pythagorean	This scale was devised by Pythagoras, the famous Greek philosopher and is created from a series of perfect fifths, which are collapsed into a single octave. The 3rd in this tuning is slightly unstable, but the 4th and 5th are beautiful and suitable for some leads.
MeanTone	This scale was created as an improvement on the Pythagorean scale, by making the major third interval more "in tune." It was especially popular from the 16th century to the 18th century. Handel, among others, used this scale.
Werckmeister/ Kirnberger	These scales combine Mean Tone and Pythagorean in different ways. With these scales, modulation changes the impression and feel of the Songs. They were often used in the era of Bach and Beethoven. They are also often used now to reproduce the music of that era on harpsichords.

To call up the desired parameter: Press the [FUNCTION] button several times to select "System" menu, then use the [^]/[v]/[<]/[>] buttons to select the desired parameter.					
[>] [<]	[>] [<]	[>] [<]	Description	Default setting	Setting range
Keyboard	Touch (page 36)	(Setting display)	Determines how the sound responds to your playing strength. This setting does not change the weight of the keyboard.	Medium	Soft 2, Soft 1, Medium, Hard 1, Hard 2, Fixed
	Fixed Velocity	(Pop-up window)	Determines the velocity with which you play the keys when Touch (above) is set to "Fixed." NOTE The setting here will not be recorded to a MIDI Song and not be transmitted as MIDI messages.	64	1 – 127
	Duo (page 32)	(Setting display)	Splits the keyboard into two ranges, allowing you to play duets over the same octave range.	Off	On, Off
	Split Point (page 30)	(Setting display)	Determines the Split Point (the boundary between the right-hand and left-hand keyboard areas).	F#2 (Split), E3 (Duo)	A-1 – C7
Pedal	Half Pedal Point (page 18)	(Pop-up window)	Here you can specify the point to which you must depress the right pedal or a pedal connected to the [AUX PEDAL] jack before the assigned effect begins to be applied. This setting applies only to the "Sustain (Continuous)" effect (page 92) that is assigned to the right or AUX pedal.	0	-2 (effective with the shallowest press) – 0 – +4 (effective with the deepest press)
	Soft Pedal Depth	(Pop-up window)	Determines how deeply the Soft pedal effect is applied. This parameter is available only for the pedal to which "Soft" (page 92) is assigned.	5	1 – 10
	Pitch Bend Range	(Pop-up window)	Determines the range of the pitch bend that is produced via the pedal in semitone steps. This setting is available only for the pedal to which "Pitch Bend Up" or "Pitch Bend Down" (page 92) is assigned. NOTE For some Voices, the pitch may not be changed according to the Pitch Bend Range value set here.	2	0 – +12 (pressing the pedal will raise/lower the pitch by 12 semitones [1 octave])
	Aux Polarity (page 18)	–	A pedal connected to the [AUX PEDAL] jack may switch on and off differently. For example, some pedals turn the effects on and others turn them off when you press them. Use this parameter to reverse this mechanism.	Make	Make, Break
	Aux Assign	(Setting display)	Assigns a function to the pedal connected to the [AUX PEDAL] jack.	Sus.Cont. (Sustain (Continuous))	Refer to the Pedal Function List (page 92).
	Aux Area	(Setting display)	Determines the keyboard area to which the function of the pedal connected to the [AUX PEDAL] jack is applied.	All	All, Right, Left
	Play/Pause	(Setting display)	Assigns the [PLAY/PAUSE] button's function to one of the Left pedal, Center pedal and pedal connected to the [AUX PEDAL] jack. If a value other than "Off" is selected here, the corresponding pedal's function assigned in the "Voice" menu (page 91) is disabled.	Off	Off, Left, Center, AUX
Sound	IAC (page 16)	–	Turns the IAC effect on or off.	On	On, Off
	IAC depth	(Pop-up window)	Determines the depth of the IAC. The higher the value, the more clearly the low/high sounds at lower volume levels.	0	-3 – +3
	Binaural (page 17)	–	Turns the Binaural Sampling function (when headphones are connected) on or off. When the function is on and headphones are connected, the sound from this instrument changes to the sound of Binaural Sampling or the sound enhanced with the Stereophonic Optimizer, allowing you to enjoy more realistic sound.	On	On, Off

To call up the desired parameter: Press the [FUNCTION] button several times to select "System" menu, then use the [^]/[v]/[<]/[>] buttons to select the desired parameter.					
[>] [<]	[>] [<]	[>] [<]	Description	Default setting	Setting range
MIDI	MIDI OUT	(Setting display)	Determines the MIDI channel on which the MIDI messages generated via the keyboard performance will be transmitted from the MIDI [OUT] or [USB TO HOST] terminal. When Dual/Split/Duo is on, the MIDI channels are assigned as follows. <ul style="list-style-type: none"> • Performance via the R1 Voice = n (setting value) • Performance via the R2 Voice = n+2 • Performance via the L Voice = n+1 	Ch1	Ch1 – Ch16, Off (not transmitted)
	MIDI IN	(Setting display)	Determines which part of the instrument will be controlled by each channel data of the MIDI messages coming from the MIDI [IN] and [USB TO HOST] terminal. <ul style="list-style-type: none"> • Song: Song part is controlled by the MIDI messages. • Keyboard: The entire keyboard is controlled regardless of the Dual/Split/Duo setting. • R1: The keyboard performance via the R1 Voice is controlled. • R2: The keyboard performance via the R2 Voice is controlled. • L: The keyboard performance via the L Voice is controlled. • Off: No part is controlled. 	"Song" for each of all MIDI channels	For each MIDI channel: <ul style="list-style-type: none"> • Song • Keyboard • R1 • R2 • L • Off
	Local Control	–	"Local Control On" is a state in which this instrument produces the sound from its tone generator when you play the keyboard. In "Local Control Off" state, the keyboard and the tone generator are cut off from each other. This means that even if you play the keyboard, this instrument will produce no sound. Instead, the keyboard data can be transmitted via MIDI to a connected MIDI device or computer, which can produce the sound. The "Local Control Off" setting is useful when you wish to play only an external sound source while playing the keys on this instrument.	On	On, Off
	Receive Param.	(Setting display)	Determines which types of MIDI messages can be received or recognized by this instrument. <p>MIDI message types: Note on/off, Control Change, Program Change, Pitch Bend, System Exclusive</p>	On (for all the MIDI messages)	On, Off (for each MIDI message)
	Transmit Param.	(Setting display)	Determines which types of MIDI messages can be transmitted from this instrument. <p>MIDI message types: Note on/off, Control Change, Program Change, Pitch Bend, SystemRealTime, System Exclusive</p>	On (for all the messages)	On, Off (for each message)
	Initial Setup	Cancel	Transmits the current panel settings such as Voice selection to a connected MIDI device or computer. Before you start recording your performance to a connected MIDI device or computer, execute this operation to record the current panel settings at the beginning of your performance data. It causes that the same panel settings are called up when the recorded performance is played back. <p>Operation: Move the highlight to "Execute," then press the [>] button to transmit the panel settings as MIDI messages.</p>	–	–
		Execute			
Backup	Backup Setting	–	For instructions about these functions, refer to pages 105 – 106.	–	–
	Backup	–			
	Restore	–			
	Factory Reset	–			

To call up the desired parameter: Press the [FUNCTION] button several times to select "System" menu, then use the [^]/[v]/[<]/[>] buttons to select the desired parameter.					
[>] [<]	[>] [<]	[>] [<]	Description	Default setting	Setting range
Utility	USB Format (page 74)	Cancel	This lets you format or initialize the USB flash drive connected to the [] (USB TO DEVICE) terminal. NOTICE Executing the Format operation will delete all data saved in the USB flash drive. Save important data to a computer or another storage device. NOTE When connecting the USB flash drive to the [] (USB TO DEVICE) terminal, a message prompting you to execute the Format operation may appear. If such a case occurs, execute the Format operation. Operation Move the highlight to "Execute," then press the [>] button to start the Format operation. After Formatting is completed, a message appears then the instrument returns to the Utility display after a while. NOTICE Never turn off the power or disconnect the USB flash drive while "Executing" is shown in the display.	-	-
		Execute			
	USB Properties	-	Shows the amount of free space and entire memory in the USB flash drive connected to the [] (USB TO DEVICE) terminal.  Amount of entire memory Amount of free space	-	-
	USB Autoload	-	When this is set to "On," the Song saved in the root directory can be selected (shown on the display) automatically as soon as the USB flash drive is connected to the [] (USB TO DEVICE) terminal.	Off	On, Off
	Speaker	(Setting display)	Lets you switch the speaker on/off. <ul style="list-style-type: none"> • Normal The speaker will sound only if headphones are not connected. • On The speaker will always sound. • Off The speaker will not sound. 	Normal	Normal, On, Off
Contrast	(Pop-up window)	Adjusts the contrast of the display.	0	-5 - +5	

To call up the desired parameter: Press the [FUNCTION] button several times to select "System" menu, then use the [^]/[v]/[<]/[>] buttons to select the desired parameter.																																																																																																																						
[>] [<]	[>] [<]	[>] [<]	Description	Default setting	Setting range																																																																																																																	
Utility	Auto Power Off (page 15)	(Setting display)	Lets you set the amount of time that elapses before the power is turned off by Auto Power Off function. To disable Auto Power Off, select "Off."	30 (minutes)	Off, 5, 10, 15, 30, 60, 120 (minutes)																																																																																																																	
	Audio Loop Back (page 85)	–	Determines whether audio input from the connected computer or smart device is output to a computer or a smart device or not.	Off	On, Off																																																																																																																	
	Audio EQ (page 85)	–	The optimum (or Equalizer) setting is provided for audio playback. When not using this EQ, set this parameter to "Off."	Off	On, Off																																																																																																																	
	Version	–	Displays the model name and the firmware version of this instrument.	–	–																																																																																																																	
	Language	System	Determines the type of characters shown on the display for the System (general indication other than Song name) and Song (Song name) individually. Character list International <table border="1" style="font-family: monospace; font-size: small;"> <tr><td>0~9</td><td>A~Z</td><td>a~z</td><td>Ä</td><td>Ë</td><td>Ï</td><td>Ö</td><td>Ü</td><td>ä</td><td>ë</td><td>ï</td><td>ö</td><td>ü</td><td>à</td><td>è</td><td>ì</td><td>ò</td></tr> <tr><td>ù</td><td>á</td><td>é</td><td>í</td><td>ó</td><td>ú</td><td>â</td><td>ê</td><td>î</td><td>ô</td><td>û</td><td>ñ</td><td>ñ</td><td>Ç</td><td>ç</td><td>°</td><td>ì</td><td>!</td><td>#</td><td>\$</td></tr> <tr><td>%</td><td>&</td><td>'</td><td>(</td><td>)</td><td>+</td><td>,</td><td>-</td><td>;</td><td>=</td><td>@</td><td>[</td><td>]</td><td>^</td><td>_</td><td>`</td><td>{</td><td>}</td><td>~</td><td>.</td></tr> </table> Japanese <table border="1" style="font-family: monospace; font-size: small;"> <tr><td>0~9</td><td>A~Z</td><td>a~z</td><td>ア</td><td>ン</td><td>ア</td><td>オ</td><td>ヤ</td><td>ユ</td><td>ヨ</td><td>ツ</td><td>ッ</td><td>°</td><td>ー</td><td>。</td></tr> <tr><td>「</td><td>」</td><td>、</td><td>・</td><td>!</td><td>#</td><td>\$</td><td>%</td><td>&</td><td>'</td><td>(</td><td>)</td><td>+</td><td>,</td><td>-</td><td>;</td><td>=</td><td>@</td><td>[</td><td>]</td><td>^</td></tr> <tr><td>_</td><td>`</td><td>{</td><td>}</td><td>~</td><td>.</td><td></td><td></td><td></td><td></td><td></td><td></td><td></td><td></td><td></td><td></td><td></td><td></td><td></td><td></td><td></td></tr> </table>	0~9	A~Z	a~z	Ä	Ë	Ï	Ö	Ü	ä	ë	ï	ö	ü	à	è	ì	ò	ù	á	é	í	ó	ú	â	ê	î	ô	û	ñ	ñ	Ç	ç	°	ì	!	#	\$	%	&	'	()	+	,	-	;	=	@	[]	^	_	`	{	}	~	.	0~9	A~Z	a~z	ア	ン	ア	オ	ヤ	ユ	ヨ	ツ	ッ	°	ー	。	「	」	、	・	!	#	\$	%	&	'	()	+	,	-	;	=	@	[]	^	_	`	{	}	~	.																International
0~9	A~Z	a~z	Ä	Ë	Ï	Ö	Ü	ä	ë	ï	ö	ü	à	è	ì	ò																																																																																																						
ù	á	é	í	ó	ú	â	ê	î	ô	û	ñ	ñ	Ç	ç	°	ì	!	#	\$																																																																																																			
%	&	'	()	+	,	-	;	=	@	[]	^	_	`	{	}	~	.																																																																																																			
0~9	A~Z	a~z	ア	ン	ア	オ	ヤ	ユ	ヨ	ツ	ッ	°	ー	。																																																																																																								
「	」	、	・	!	#	\$	%	&	'	()	+	,	-	;	=	@	[]	^																																																																																																		
_	`	{	}	~	.																																																																																																																	

The following menu is shown only when you connect the USB wireless LAN adaptor to the [] (USB TO DEVICE) terminal on this instrument.

Menus marked with * differ in the Wireless LAN Mode parameters between the two modes: "Infrastructure" and "Accesspoint." The default setting for the Wireless LAN Mode is "Infrastructure."

To call up the desired parameter:							
Press the [FUNCTION] button several times to select "System" menu, then use the [^]/[v]/[<]/[>] buttons to select the desired parameter.							
[>] [<]	[>] [<]	[>] [<]	[>] [<]	[>] [<]	Description	Default setting	Setting range
Utility	Wireless LAN* (In the "Infrastructure" mode)	Select Network	(Networks)		Connects to an access point by selecting the network.	–	–
			Other	SSID	Sets the SSID.	–	Up to 32 characters (half size), alphanumeric characters, marks
				Security	Sets the Security.	None	None, WEP, WPA2-PSK (AES), WPA/WPA2 mixed PSK
				Password	Sets the Password.	–	Up to 64 characters (half size), alphanumeric characters, marks
				Connect	Connects using the settings in "Other" display.	–	–
		Detail	DHCP		Sets the wireless LAN detailed settings. IP Address, Subnet Mask, Gateway, DNS Server1, DNS Server2 can be set when DHCP is set to Off while cannot be set when DHCP set to On. Use the [<]/[>] buttons to select each octet in the entry display, then enter the value using the [^]/[v] buttons. To finalize the setting, press the [FUNCTION] button.	On	On/Off
			IP Address			0.0.0.0	0.0.0.0-255.255.255.255
			Subnet Mask			0.0.0.0	0.0.0.0-255.255.255.255
			Gateway			0.0.0.0	0.0.0.0-255.255.255.255
			DNS Server1			0.0.0.0	0.0.0.0-255.255.255.255
	DNS Server2			0.0.0.0	0.0.0.0-255.255.255.255		
	Save		Saves the settings in the "Detail" display. Move the highlight to "Save," then press the [>] button to execute the Saving.	–	–		
	Wireless LAN Option*	Wireless LAN Mode	Infrastructure Mode	Determines whether the access point is used for wireless LAN connection (Infrastructure Mode) or not (Accesspoint Mode).	Infrastructure Mode	–	
			Accesspoint Mode				
		Initialize	Cancel	Initializes the settings in the "Wireless LAN" display. Move the highlight to "Execute," then press the [>] button to execute the initialization.	Cancel	–	
			Execute				
		Detail	Host Name		Sets the Host name.	[P515]-[xxxxxx (MAC address lower 6 figure)]	Up to 57 characters (half size) including alphanumeric characters, the "_" (underscore) and "-" (hyphen) character.
			Mac Address		Displays the MAC address of the USB wireless LAN adaptor.	–	–
			Status		Displays the error code of network function.	–	–

To call up the desired parameter:

Press the [FUNCTION] button several times to select "System" menu, then use the [^]/[v]/[<]/[>] buttons to select the desired parameter.

[>] [<]	[>] [<]	[>] [<]	Description	Default setting	Setting range
Utility	Wireless LAN* (In the "Accesspoint" mode)	SSID	Sets the SSID as an access point.	ap-[P-515]-[xxxxxx (MAC address lower 6 figure)]	Up to 32 characters (half size), alphanumeric characters, marks
		Security	Sets the Security as an access point.	WPA2-PSK (AES)	None, WEP, WPA2-PSK (AES), WPA/WPA2 mixed PSK
		Password	Sets the Password as an access point.	00000000	Up to 64 characters (half size), alphanumeric characters, marks
		Channel	Sets the channel as an access point.	11	Differs depending on the USB wireless LAN adaptor models. <ul style="list-style-type: none"> • Models for United States and Canada: 1 – 11 • Others: 1 – 13 When no USB wireless LAN adaptor is connected, setting range is channels 1 – 13.
		DHCP Server	Sets the IP address related settings.	On	On, Off
		IP Address		192.168.0.1	192. 168. 0-255. 1-254.
		Subnet Mask		255.255.255.0	255.255.0.0, 255.255.128.0, 255.255.192.0, 255.255.224.0, 255.255.240.0, 255.255.248.0, 255.255.252.0, 255.255.254.0, 255.255.255.0
		Save	Saves the settings you set in the "Wireless LAN" display (in the "Accesspoint" mode)	–	–

■ Backup Setting

(Selecting parameters maintained even when the power is turned off)

This lets you set whether some settings of the Backup Setting (below) are maintained or not when the power is turned off. The Backup Setting consists of two groups, “Voice” (including Voice related settings such as Voice selection) and “Other” (including various settings such as Song Repeat and Tuning), which can be set individually.

Data and settings maintained even when the power is turned off

- User MIDI Song (saved in this instrument’s “User” memory)
- *Bluetooth** (“System” menu)
- Utility (“System” menu)
- Backup Setting (explained here)

* For information on whether *Bluetooth* functionality is included with the instrument or not, refer to page 8.

1. Press the [FUNCTION] button several times to select “System” menu.
2. Use the [^]/[v] buttons to select “Backup,” use the [>] button to call up the next display, then press the [^] button to select “Backup Setting.”
3. Use the [>] then the [^] button to select “Voice,” then use the [>] button to select “On” or “Off.”
Each “Voice” contains the following settings:
 - Voice selection for R1, R2 and L
 - All the parameters other than Transpose in the “Voice” menu
4. Press the [v] button to select “Other,” then use the [>] button to select “On” or “Off.”
The “Other” contains the following settings:
 - In the “Song” menu: Song Repeat, Song-Keyboard, Audio Volume, Quick Play, Play Track
 - In the “Metronome/Rhythm” menu: Volume, BPM, Bell On/Off, Bass, Intro, Ending
 - In the “System” menu: Tuning, Keyboard (except “Duo”), Pedal, Sound, MIDI
 - Sound Boost, Master EQ
5. Press the [EXIT] button to exit from the “System” menu display.

■ Backup

(Saving the Backup file for internal data)

This lets you save data on internal memory to the connected USB flash drive as a backup file (named “p-515.bup”). This backup file can be loaded to the instrument via the Restore function (page 106) for future.

NOTICE

- It may take 1 – 2 minutes to complete this operation. Never turn off the power during this operation (while “Executing” is shown). Doing so could result in damage to the data.
- If the same backup file (p-515.bup) is already saved in the USB flash drive, this operation will overwrite or replace this file with new one.

1. Connect the USB flash drive to the [] (USB TO DEVICE) terminal.
2. Press the [FUNCTION] button several times to select “System” menu.
3. Use the [^]/[v] buttons to select “Backup,” use the [>] button to call up the next display, then use the [^]/[v] buttons to select “Backup.”
4. Use the [>] button to call up the next display, then press the [v] button to select “Execute.”
5. Press the [>] button to execute the Backup operation.
6. Press the [EXIT] button to exit from the “System” menu display.

NOTE

When you want to restore the settings in the backup file, execute the Restore function (page 106).

NOTE

Protected Songs cannot be backed up.

■ Restore

(Restarting the instrument with the Backup file loaded)

This lets you load the backup file (p-515.bup) saved via the Backup function (page 105) to the instrument on.

NOTICE

- It may take 1 – 2 minutes to complete this operation. Never turn off the power during this operation (while “Executing” is shown). Doing so could result in damage to the data.
- If Protected Songs or recorded Songs reside on “User” memory, make sure to move the Songs to the USB flash drive by following the instructions page 69 before executing this operation. If you do not, the Songs will be deleted via this operation.

1. Connect the USB flash drive containing the Backup file to the [] (USB TO DEVICE) terminal.
2. Press the [FUNCTION] button several times to select “System” menu.
3. Use the [^]/[v] buttons to select “Backup,” use the [>] button to call up the next display, then use the [^]/[v] buttons to select “Restore.”
4. Use the [>] button to call up the next display, then press the [v] button select “Execute.”
5. Press the [>] button to execute the Restore operation.

A message indicating that the operation is completed appears, then the instrument will restart after a while.

■ Factory Reset

(Restarting the instrument with the initial factory settings loaded)

This lets you reset this instrument to its factory default settings which refers to the initial setting preprogrammed when shipped from the factory, and is called up when you first turn on the power to this instrument.

Note that the following points.

- This operation resets the Backup Setting (page 105) to the default setting.
- This operation will not delete the Songs saved in the User folder.

- This operation will not delete the *Bluetooth** pairing information (page 82).

* For information on whether *Bluetooth* functionality is included with the instrument or not, refer to page 8.

NOTICE

Never turn off the power during this operation (while “Factory reset executing” is shown). Doing so could result in damage to the data.

1. Press the [FUNCTION] button several times to select “System” menu.
2. Use the [^]/[v] buttons to select “Backup,” use the [>] button to call up the next display, then use the [^]/[v] buttons to select “Factory Reset.”
3. Use the [>] button to call up the next display, then press the [v] button to select “Execute.”
4. Press the [>] button to execute the Restore operation.

A message indicating that the operation is completed appears, then the instrument will restart after a while.

● Alternate method for restoring the default settings

Press and hold down the white key on the right end (C7) and press the [⏻] (Standby/On) switch to turn on the power to this instrument. This operation will not delete the Songs in the User folder.

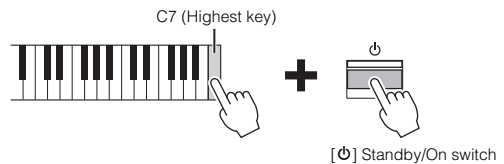

Preset Voice List

Voice Group	Voice Name	Stereo Sampling	Touch Sense	Key-off Sampling	VRM	Voice Demo	Voice description
Piano	CFX Grand	○	○	○	○	○	Yamaha's CFX concert grand piano sound with a wide dynamic range for maximum expressive control. Suitable for playing in any music genre and style.
	Binaural CFX Grand	○	○	—	○	○	Yamaha's CFX concert grand piano sound sampled by Binaural Sampling, the method optimized for headphone use. Listening this through headphones gives the impression of being immersed in the sound, as if it was actually emanating from the piano. This Voice is selected automatically when headphones are connected.
	Bösendorfer	○	○	○	○	● ⁽¹⁾	The famed sound of the Vienna-made Bösendorfer Imperial concert grand piano. Its spacious sound evokes the size of the instrument, and is ideal for expressing tenderness in compositions.
	Studio Grand	○	○	○	○	○	The sound of Yamaha's C7 grand piano, which is often used in recording studios. Its bright and clear sound is good for popular styles.
	Bright Grand	○	○	○	○	—	Bright piano sound. Good for clear expression and "cutting through" other instruments in an ensemble.
	Ballad Grand	○	○	○	○	—	Grand piano sound with a soft and warm tone. Good for playing ballads.
	Warm Grand	○	○	—	○	—	Warm and soft piano sound. Good for relaxing music.
	Pop Grand	○	○	○	○	—	A slightly brighter piano sound. Good for popular styles.
	Jazz Grand	○	○	—	○	—	A piano sound with unique tonal character. Good for jazz styles.
	Rock Grand	○	○	○	○	—	A bright-sounding piano. Ideal for rock styles.
Honky/Tonk Pf	○	○	—	○	—	A honky-tonk style piano. Enjoy a tonal character that is quite different than a grand piano.	
E.Piano	Stage E.Piano	—	○	○	—	○	The sound of an electric piano using hammer-struck metallic "tines." Soft tone when played lightly, and an aggressive tone when played hard.
	DX E.Piano	—	○	—	—	○	An electronic piano sound produced by an FM synthesizer. The tone will change as you vary your playing touch. Ideal for popular music.
	Vintage EP	—	○	○	—	○	A different type of electric piano sound than Stage E.piano. Widely used in rock and popular music.
	Soft EP	—	○	○	—	—	An electric piano with a characteristic panning effect. Good for playing quiet ballads.
	Phaser EP	—	○	○	—	—	A distinctive phaser effect makes this ideal for fusion styles.
	DX Bright	—	○	—	—	—	A variation of electronic piano sound produced by an FM synthesizer. Its bright and sparkling sound character spice up the music.
	Tremolo Vintage	—	○	○	—	—	Includes tremolo ideal for Vintage EP. Frequently used in rock music.
Organ	Jazz Organ Slow	—	—	—	—	○	The sound of a "tonewheel" type electric organ. Sampled with Rotary SP effect, its rotation speed is slow. Often heard in jazz and rock idioms.
	Jazz Organ Fast	—	—	—	—	—	A same type of electric organ sound as Jazz Organ Slow. This was sampled with the fast rotation speed of the rotary speaker effect. Switch Voices between Jazz Organ Slow and Jazz Organ Fast to add variations to your performance.
	Rock Organ	—	—	—	—	○	Bright and sharp electric organ sound. Optimum for rock music.
	Jazz Organ	—	—	—	—	—	The sound of a "tonewheel" type electric organ. Often heard in jazz and rock idioms. When connecting the separately sold pedal unit, LP-1, you can switch "fast" and "slow" of the Rotary Speaker (Rotary Speed) using the left pedal.
	Organ Principal	○	—	—	—	● ⁽²⁾	This Voice features the combination of pipes (8'+4'+2') of a principal (brass instrument) organ. It is suitable for Baroque church music.
	Organ Tutti	○	—	—	—	○	This Voice features a full coupler of a pipe organ, famous for the sound used in Toccata and Fugue by Bach.
CLV./VIB.	Harpichord 8'	○	—	○	—	● ⁽³⁾	The sound of the instrument frequently used in baroque music. Variations in playing touch will not affect the volume, and a characteristic sound will be heard when you release the key.
	Harpsi. 8'+4'	○	—	○	—	—	A harpsichord with an added upper octave. Produces a more brilliant sound.
	E.Clavichord	—	○	○	—	○	This is the voice of a keyboard that produces sound by striking strings and using magnetic pickups. This 'funky' sound is popular in soul and rhythm and blues music. Because of its unique mechanism, the instrument produces a peculiar sound when you release the keys.
	Vibraphone	○	○	—	—	○	A Vibraphone sound, sampled in stereo. Its spacious and clear sound is ideal for popular music.
Strings	Strings	○	○	—	—	○	Stereo-sampled, large-scale strings ensemble with realistic reverb. Try combining this Voice with piano in the Dual mode.
	Slow Strings	○	○	—	—	—	The sound of a string ensemble, with a slow attack. Suitable for use in Dual mode with piano or electric piano.
	Choir	—	○	—	—	○	A big, spacious choir Voice. Perfect for creating rich harmonies in slow pieces.

Voice Group	Voice Name	Stereo Sampling	Touch Sense	Key-off Sampling	VRM	Voice Demo	Voice description
Strings	Slow Choir	—	○	—	—	—	The sound of a choir with a slow attack. Suitable for use in Dual mode with piano or electric piano.
	Dark Pad	—	○	—	—	○	Warm and spacious synth sound. Ideal for sustained parts in the background of an ensemble, or for use in Dual mode with piano or electric piano.
	Lite Pad	—	○	—	—	—	Bright and spacious synth sound. Ideal for sustained parts in the background of an ensemble, or for use in Dual mode with piano or electric piano.
	Bell Pad	○	○	—	—	—	Synth sound with a crisp, bell-like sound. Ideal for layering in Dual mode with a piano or electric piano sound, but also produces a bright, gorgeous sound on its own.
Others	Acoustic Bass	—	○	—	—	○	The sound of a finger-plucked acoustic bass. Frequently used in jazz and Latin music.
	Electric Bass	—	○	—	—	○	The sound of an electric bass. Frequently used in jazz, rock, and popular music.
	Bass & Cymbal	—	○	—	—	—	The sound of a cymbal layered with acoustic bass. Effective when used for jazz walking-bass lines.
	Fretless Bass	—	○	—	—	○	The sound of a fretless bass. Suitable for styles such as jazz and fusion.
	Nylon Guitar	○	○	—	—	○	Stereo-sampled, nylon-string guitar with natural reality. Suitable for any style of musics.
	Steel Guitar	—	○	—	—	—	A bright steel-string guitar sound. Ideal for popular music.
XG	XG	—	○	—	—	○	For details on XG Voices, refer to the "XG Voice list" in the Data List on the website (page 9).

VRM

Simulated string resonance sound with physical modeling when the damper pedal is pressed or keys are pressed.

Key-off Sampling

Samples of the very delicate noises that are produced when keys are released.

Voice Demo List

	Voice Group	Voice Name	Title	Composer
● ⁽¹⁾	Piano	Bösendorfer	Mädchens Wunsch (6 Chants polonaise S.480 R.145)	F. Liszt / F. F. Chopin
● ⁽²⁾	Organ	Organ Principal	Herr Christ, der ein'ge Gottes-Sohn, BWV 601	J. S. Bach
● ⁽³⁾	CLV./VIB.	Harpsichord 8'	Concerto a cembalo obbligato, 2 violini, viola e continuo No.7, BWV 1058	J. S. Bach

The Voice Demos with (●) listed above are short rearranged excerpts of the original compositions. All other Demo Songs are Yamaha original (© Yamaha Corporation).

Song List

50 Classics

No.	Song Title	Composer
Arrangements		
1	Canon D dur	J. Pachelbel
2	Air On the G String	J. S. Bach
3	Jesus, Joy of Man's Desiring	J. S. Bach
4	Twinkle, Twinkle, Little Star	Traditional
5	Piano Sonate op.31-2 "Tempest" 3rd mov.	L. v. Beethoven
6	Ode to Joy	L. v. Beethoven
7	Wiegenlied op.98-2	F. P. Schubert
8	Grande Valse Brillante	F. F. Chopin
9	Polonaise op.53 "Héroïque"	F. F. Chopin
10	La Campanella	F. Liszt
11	Salut d'amour op.12	E. Elgar
12	From the New World	A. Dvořák
13	Sicilienne	G. U. Fauré
14	Clair de lune	C. A. Debussy
15	Jupiter (The Planets)	G. Holst
Duets*		
16	Menuett (Eine kleine Nachtmusik K.525)	W. A. Mozart
17	Menuett G dur	L. v. Beethoven
18	Marcia alla Turca	L. v. Beethoven
19	Piano Concerto No.1 op.11 2nd mov.	F. F. Chopin
20	The Nutcracker Medley	P. I. Tchaikovsky
Original Compositions		
21	Prelude (Wohlt temperierte Klavier I No.1)	J. S. Bach
22	Menuett G dur BWV Anh.114	J. S. Bach
23	Piano Sonate No.15 K.545 1st mov.	W. A. Mozart
24	Turkish March	W. A. Mozart
25	Piano Sonate op.13 "Pathétique" 2nd mov.	L. v. Beethoven
26	Für Elise	L. v. Beethoven
27	Piano Sonate op.27-2 "Mondschein" 1st mov.	L. v. Beethoven
28	Impromptu op.90-2	F. P. Schubert
29	Frühlingslied op.62-6	J. L. F. Mendelssohn
30	Fantaisie-Impromptu	F. F. Chopin
31	Etude op.10-3 "Chanson de l'adieu"	F. F. Chopin
32	Etude op.10-12 "Revolutionary"	F. F. Chopin
33	Valse op.64-1 "Petit chien"	F. F. Chopin
34	Nocturne op.9-2	F. F. Chopin
35	Nocturne KK4a-16/BI 49 [Posth.]	F. F. Chopin
36	Träumerei	R. Schumann
37	Barcarolle	P. I. Tchaikovsky
38	La prière d'une Vierge	T. Badarzewska
39	Liebesträume No.3	F. Liszt
40	Blumenlied	G. Lange
41	Humoresque	A. Dvořák
42	Arietta	E. H. Grieg
43	Tango (España)	I. Albéniz
44	The Entertainer	S. Joplin
45	Maple Leaf Rag	S. Joplin
46	La Fille aux Cheveux de Lin	C. A. Debussy
47	Arabesque No.1	C. A. Debussy
48	Cakewalk	C. A. Debussy
49	Je te veux	E. Satie
50	Gymnopédies No.1	E. Satie

* Regarding the "Duets" Songs, the right-hand part is for the right hand of the first player, the left-hand part is for the left hand of the first player, and Extra part is for the both hands of the second player.



Rhythm List

Category	No.	Name
Pop&Rock	1	8Beat1
	2	8Beat2
	3	8Beat3
	4	16Beat1
	5	16Beat2
	6	Shuffle1
	7	Shuffle2
	8	Shuffle3
	9	Shuffle4
	10	8BeatBallad1
	11	8BeatBallad2
	12	16BeatBallad
	13	6-8Ballad1
	14	6-8Ballad2
	15	PopWaltz
	16	Funk
	17	Disco
	18	Twist
	19	Dance
	20	ChillOut
Jazz	21	FastJazz1
	22	FastJazz2
	23	FastJazz3
	24	SlowJazz1
	25	SlowJazz2
	26	SlowJazz3
	27	JazzWaltz
	28	Five-Four
World	29	Country
	30	Gospel
	31	Samba
	32	BossaNova
	33	Rumba
	34	Salsa
	35	AfroCuban
	36	Reggae
Kids&Holiday	37	KidsPop
	38	6-8March
	39	ChristmasSwing
	40	Christmas3-4

Message List

Some message display remains open. In this case, press the [EXIT] button to close message display.

Message	Meaning
Access error	The operation has failed. The following causes can be considered. If the following are not responsible, the file may be damaged. <ul style="list-style-type: none"> • The file operation is wrong. Follow the instructions in "Handling Song Files" (page 66) or "Backup"/"Restore" (pages 105 – 106). • The connected USB flash drive is not compatible with this instrument. For information on compatible USB flash drive, see page 74. • The protected Song on which you attempted the operation is defective.
Bluetooth pairing...	The instrument is standing by for <i>Bluetooth</i> pairing. Refer to the instructions on page 81.
Cannot be executed	The operation has failed. The following causes can be considered. Solve the causes, and try again. <ul style="list-style-type: none"> • The file operation you attempted cannot be executed to Preset Songs or an Audio Song. For information on the limitation of handling Song files, see page 66.
Change to Current Tempo	This message indicates that you are applying the current tempo to the selected Song.
Change to Current Voice	This message indicates that you are changing the Voice of the Song with the current Voice.
Completed	This message indicates that the operation is completed. Go on to the next step.
Completed Restart now	Restore is completed. The instrument is automatically turned on again.
Convert canceled	This message appears when the convert operation is canceled.
Convert completed to USB/USERFILES/	This message appears when the convert operation to the "USER FILES" folder on a USB flash drive is completed.
Convert to Audio	This message appears during the convert operation.
Copy completed to USB/USERFILES/	This message appears when the copy operation to the "USER FILES" folder on a USB flash drive is completed.
Copy completed to User	This message appears when the copy operation to the "User" on this instrument is completed.
Device busy	The operation, such as converting to the Audio Song or Audio Song playback/recording, has failed. This message appears when you attempt to use a USB flash drive to which recording/deleting operations are repeated. Execute the Format operation after making sure there is no important data in the USB flash drive (page 101), and try again.
Device removed	This message appears when the USB flash drive is removed from the instrument.
Duplicate name	This message indicates that an identically named file already exists. Rename the file (page 71).
Executing	The instrument is executing the operation. Wait until the message disappears, then go on to the next step.
Factory reset executing Memory Song excluded	The default settings (except the Songs in the "User") have been restored (page 106). This message also appears if you press and hold down the C7 key and turn on the power to the instrument.
Factory reset completed Restart	Factory reset is completed. The instrument is then restarted.
Incompatible device	This message appears when an incompatible USB flash drive is connected. Use a device whose compatibility has been confirmed by Yamaha (page 74).
Internal hardware error	A malfunction has occurred in the instrument. Contact your nearest Yamaha dealer or authorized distributor.
Last power off invalid Checking memory	This message appears when the power is turned on after turning off the power while handling a Song file (page 66) or saving a backup file (page 105). The internal memory is being checked while this message appears. If the internal settings are damaged, they will be reset to the default settings. If the Songs in the "User" are damaged, they will be deleted.
Maximum no. of devices exceeded	The number of devices exceed the limitation. Up to two USB devices can be connected simultaneously. For details, see page 74.
Memory full	Since the capacity and the number of files in the "User"/USB flash drive are full, the operation cannot be completed. Delete some Songs in the "User"/USB flash drive (page 68) or move Songs to another USB flash drive (page 69), and try again.
Move completed to USB/USERFILES/	This message appears when the move operation to the "USER FILES" folder on a USB flash drive is completed.
Move completed to User	This message appears when the move operation to "User" on the instrument is completed.
No device	A USB flash drive was not connected to the instrument when you attempted to perform a device-related operation. Connect the device, and try again.

Message	Meaning
No response from USB device	The instrument cannot communicate with the connected USB device. Redo the connection (page 74). If you still see this message, the USB device may be damaged.
Notice: Protected Song	This message appears when you attempt to handle the Protected Song. For information on the limitation of file operations, see page 66.
Please wait	The instrument is processing the data. Wait until the message disappears, then go on to the next step.
Protected device	This message appears when you attempt a file operation (page 66), record your performance or save the data on a read-only USB flash drive. Cancel the read-only setting, if possible, and try again. If you still see this message, the USB flash drive is internally protected (such as commercially available music data). You cannot make the file operation or record your performance to such a device.
Protected Song	You attempted a file operation to a Protected Song or read-only file. Data of those types have handling limitations (page 66), and also cannot be used for editing (page 62). Use a read-only file after cancelling the read-only setting.
Remaining space on drive is low	Since the remaining space on the "User"/USB flash drive is low, delete any unnecessary files (page 68) before recording.
Same file name exists	This message appears to prompt you to confirm if overwriting or not when executing a Copy/Move/MIDI to Audio operation.
Song error	This message appears, if a problem is found with the Song data when you select a Song or while the Song is playing. In this case, reselect the Song, and try again to play back. If the message still appears, the Song data may have been damaged.
Song too large	The size of Song data (MIDI/Audio) exceeds the limitation. The following causes can be considered. <ul style="list-style-type: none"> • The Song size you attempt to play back exceeds the limitation. The limitation for playback is approx. 500KB (MIDI), 80 minutes (Audio). • The Song size exceeds the limitation during recording. The limitation for recording is approx. 500KB (MIDI), 80 minutes (Audio). The recording will end automatically and the recorded data before the end is saved. • The Song size exceeds the limitation during converting a MIDI Song to an Audio Song. The limitation is 80 minutes (Audio).
System limit	This message appears when the number of files exceeds the system limit. The maximum number of files and folders which can be saved in a folder is 250. Try again after deleting/moving the unnecessary file(s).
This data format is not supported	This message appears when you attempted to load a Song of unsupported format to this instrument. Refer to the page 8 about supported Song formats.
Unformatted device	This message appears when you attempt to use an unformatted USB flash drive. Format it (page 101), and try again.
Unsupported device	This message appears when an unsupported USB flash drive is connected. Use a device whose compatibility has been confirmed by Yamaha (page 74).
USB device overcurrent error	Communication with the USB device has been cut off because of an abnormal power surge to the device. Disconnect the USB device from the [] (USB TO DEVICE) terminal and turn the [] (Standby/On) switch of the instrument standby and on again.
USB hub hierarchical error	The USB hub is connected in two layers. USB hub use is limited to one layer.
USB power consumption exceeded	A bus-powered USB hub is usually recommended. When this message appears, however, use a self-powered USB hub (with its own power source) and turn the power to on, or use a device whose compatibility has been confirmed by Yamaha (page 74).
Wrong device	The file operation cannot be made to the connected USB flash drive. The following causes can be considered. <ul style="list-style-type: none"> • The USB flash drive is not formatted. Format it (page 101), and try again. • The number of files exceeds the system limit. The maximum number of files and folders which can be saved in a folder is 250. Try again after deleting/moving the unnecessary file(s).
Wrong name	The Song name is not appropriate. This message appears during the "Renaming files" (page 71) operation because of the following causes. Rename the Song correctly. <ul style="list-style-type: none"> • No character has been input. • You used a period or space at the beginning/ending of a Song name.

Troubleshooting

When a message is displayed, refer to the “Message List” (page 110) for troubleshooting aid.

Problem	Possible Cause and Solution
The instrument does not turn on.	The instrument has not been plugged in properly. Securely connect the AC adaptor to the DC IN jack on the instrument and to the AC outlet (page 14).
A click or pop is heard when the power is turned on or off.	This is normal when electrical current is being applied to the instrument.
The power is automatically turned off.	This is normal and due to the Auto Power Off function. If necessary, set the parameter of the Auto Power Off function (page 15).
The message “USB device overcurrent error” is shown and the USB device does not respond.	Communication with the USB device has been shut down because of the overcurrent to the USB device. Disconnect the device from the [] (USB TO DEVICE) terminal, then turn on the power of the instrument.
Noise is heard from the speakers or headphones.	The noise may be due to interference caused by the use of a mobile phone in close proximity to the instrument. Turn off the mobile phone, or use it further away from the instrument.
Noise is heard from the instrument's speakers or headphones when using the instrument with your smart device, such as an iPhone/iPad.	When you use the instrument along with your smart device, we recommend that you set that device's “Airplane Mode” to “ON” and then the Wi-Fi/Bluetooth setting to “ON” on your smart device in order to avoid noise caused by communication.
The overall volume is low, or no sound is heard.	The Master Volume is set too low; set it to an appropriate level using the [MASTER VOLUME] slider (page 16).
	The volume level for the keyboard performance is set too low. Adjust the volume balance to increase the keyboard volume via the “Song” menu display: “Volume” → “Song - Keyboard” (page 52).
	Headphones are connected when the Speaker setting is “Normal” (page 101). Disconnect the headphone plug.
	The Speaker setting is “Off.” Set the Speaker to “Normal” or “On” via the “System” menu display: “Utility” → “Speaker” (page 101).
	Local Control is “Off.” Set Local Control “On” via the “System” menu display: “MIDI” → “Local Control” (page 100).
The speakers do not switch off when a pair of headphones is connected to the [PHONES] jack.	The Speaker setting is “On.” Set the speaker setting to “Normal” via the “System” menu display: “Utility” → “Speaker” (page 101).
Pedals do not function.	The pedal cord may not be securely connected to the [PEDAL UNIT] jack. Be sure to insert the pedal cord all the way until the metal part of the cord plug disappears from view.
The on/off setting of the pedal connected to the AUX PEDAL jack is reversed.	Some types of pedals may turn on and off in opposite fashion. Set to the appropriate parameter via the “System” menu display: “Pedal” → “Aux Polarity” (page 99).
The keyboard volume is lower than the Song playback volume.	The volume level for the keyboard performance is set too low. Adjust the volume balance to increase the keyboard volume via the “Song” menu display: “Volume” → “Song - Keyboard” (page 52).
The buttons do not respond.	While you are using a function, some buttons not used for the function are disabled. If the Song is playing, stop playback. Otherwise, press the [EXIT] button to return to the Voice or Song display. Then, perform the desired operation.
Higher or lower notes do not sound correctly when the transpose or octave setting is made.	This instrument can cover the range of C -2 – G8 when you set the transposition or octave. If notes lower than C -2 are played, the sound is moved one octave higher. If notes higher than G8 are played, the sound is moved one octave lower.
Performance in Dual/Split/Duo mode is not recorded, or part data is lost unexpectedly.	Switching to Dual/Split/Duo mode in the middle of the Song is not recorded. Also, the recording part for the Voice 2 (Dual mode) or the left Voice (Split/Duo mode) is automatically assigned (page 57). If the assigned part already has data, the data will be overwritten and deleted when you record.
Depending on the selected Voice, the keyboard sound in Duo mode may be output from only one speaker.	This is because the default pan setting differs depending on the Voice. Change the settings from the “Voice” menu → “Voice Edit” → “Voice name” → “Pan” (page 90).

Problem	Possible Cause and Solution
The Song title is not correct.	The "Language" setting may be different than that is selected when you named the Song. Also, if the Song was recorded on another instrument, the title might be displayed incorrectly. Set the "Language" parameter (page 102) via the "System" menu display: "Utility" → "Language" → "Song" to change the setting. However, if the Song was recorded on another instrument, changing the "Language" parameter setting may not resolve the problem.
Menu display cannot be called up.	When Song is being played back, menu display other than "Voice" menu and "Song" menu will not appear. Stop the Song by pressing the [PLAY/PAUSE] button. Also, in the recording ready mode, only "Recording" menu display will appear.
Rhythm does not start.	"SyncStart" setting is on. Set "SyncStart" off in the "Metronome/Rhythm" menu display.
The contents of the Wireless LAN is not shown in the display even though the USB wireless LAN adaptor is connected.	Disconnect the USB wireless LAN adaptor and connect it again.
The <i>Bluetooth</i> -equipped smart device cannot be paired with nor connected to the instrument.	Check the <i>Bluetooth</i> function of the smart device is activated. To connect the smart device and the instrument via <i>Bluetooth</i> , both devices need to be functional.
	The smart device and the instrument need to be paired to connect each other via <i>Bluetooth</i> (page 8).
	In case there is a device (microwave oven, wireless LAN device, etc.) that outputs signals in the 2.4 GHz frequency band nearby, move this instrument away from the device that is emitting radio-frequency signals.
Sound input via the [AUX IN] jack or <i>Bluetooth</i> is interrupted.	The Noise Gate function of this instrument cuts unwanted noise from the input sound. However, this may result in wanted sounds also being cut, such as the soft decay sound of a piano. This is normal and not a sign of malfunction.

*For information on whether *Bluetooth* functionality is included or not, refer to page 8.

Specifications

Items			P-515
Product Name			DIGITAL PIANO
Size/Weight	Dimensions (W x D x H)		1336 mm x 376 mm x 145 mm (52-5/8" x 14-13/16" x 5-11/16")
	Weight		22.0 kg (48 lb, 8 oz)
Control Interface	Keyboard	Number of Keys	88
		Type	NWX (Natural Wood X) keyboard: wooden keys (white only), synthetic ebony and ivory keytops, escapement
		Touch Response	Hard2/Hard1/Medium/Soft1/Soft2/Fixed
	Pedal	Number of pedals	3 (When using the pedal unit, LP-1)
		Assignable Functions	Sustain (Switch), Sustain (Continuous), Sostenuto, Soft, Pitch Bend Up, Pitch Bend Down, Rotary Speed, Vibe Rotor, Song Play/Pause
	Display	Type	Full Dots LCD
		Size	128 x 64 dots
		Language	English, Japanese
Panel	Language	English	
Voices	Tone Generation	Piano Sound	Yamaha CFX, Bösendorfer Imperial
		Binaural Sampling	Yes (CFX Grand Voice only)
	Piano Effects	VRM	Yes
		Key-off Samples	Yes
		Smooth Release	Yes
	Polyphony (max.)		256
	Preset	Number of Voices	40 Voices + 18 Drum/SFX Kits + 480 XG Voices
Compatibility		XG (GM), GS (for Song playback), GM2 (for Song playback)	
Effects	Types	Reverb	6 types
		Chorus	3 types
		Effect	12 types
		Intelligent Acoustic Control (IAC)	Yes
		Stereophonic Optimizer	Yes
	Functions	Dual	Yes
		Split	Yes
		Duo	Yes
		Master EQ	3 Preset + 1 User
		Soundboost	3 types
Songs (MIDI)	Preset	Number of Preset Songs	21 Voice Demo Songs + 50 Classics
	Recording	Number of Songs	250
		Number of Tracks	16
		Data Capacity	Approx. 500 KB/Song
	Playback	Data Capacity	Approx. 500 KB/Song
	Format	Playback	SMF (Format 0, Format 1)
Recording		SMF (Format 0)	
Songs (Audio)	Recording Time (max.)		80 minutes/Song
	Format	Playback	WAV (44.1 kHz, 16 bit, Stereo)
		Recording	WAV (44.1 kHz, 16 bit, Stereo)
Functions	Rhythms	Preset	40
	Overall Controls	Metronome	Yes
		Tempo Range	5 – 500
		Transpose	-12 – 0 – +12
		Tuning	414.8 – 440.0 – 466.8 Hz (approx. 0.2 Hz increments)
		Scale Type	7 types
	USB audio interface		44.1 kHz, 16 bit, Stereo

Items		P-515	
Functions	<i>Bluetooth</i> * This function may not be included depending on the country in which you purchased the product. Refer to page 81 for details.	<i>Bluetooth version</i>	4.1
		Supported profile	A2DP
		Compatible codec	SBC
		Wireless output	<i>Bluetooth class 2</i>
		Maximum communication distance	Approx. 10 m
		Range of transmit frequency	2,402 – 2,480 MHz
		Maximum RF output power	4 dBm
	Miscellaneous	Piano Room	Yes
Storage and Connectivity	Storage	Internal Memory	Total maximum size approx. 1.4 MB
		External Device	USB flash drive
	Connectivity	DC IN	16 V
		Headphones	Standard stereo phone jack (x 2)
		MIDI	IN, OUT
		AUX IN	Stereo mini jack
		AUX OUT	L/L+R, R
		AUX PEDAL	Yes
		PEDAL UNIT	Yes
		USB TO DEVICE	Yes
USB TO HOST	Yes		
Sound System	Amplifiers	(15 W + 5 W) x 2	
	Speakers	(Oval (12 cm x 6 cm) + 2.5 cm (dome)) x 2	
	Acoustic Optimizer	Yes	
Power Supply	AC Adaptor	PA-300C or an equivalent recommended by Yamaha	
	Power Consumption	15 W (When using PA-300C AC adaptor)	
	Auto Power Off	Yes	
Included Accessories		<ul style="list-style-type: none"> • Owner's Manual • Warranty* • Online Member Product Registration • Power cord*, AC adaptor PA-300C or an equivalent recommended by Yamaha* • Footswitch FC4A • Music Rest <p>* May not be included depending on your area. Check with your Yamaha dealer.</p>	
Separately Sold Accessories (May not be available depending on your area.)		<ul style="list-style-type: none"> • Keyboard Stand L-515 • Pedal Unit LP-1 • Foot Pedal FC3A • Footswitch FC5 • Headphones HPH-150/HPH-100/HPH-50 • AC adaptor PA-300C or an equivalent recommended by Yamaha • USB Wireless LAN Adaptor UD-WL01 • Wireless MIDI Adaptor UD-BT01/MD-BT01 	

* The contents of this manual apply to the latest specifications as of the publishing date. To obtain the latest manual, access the Yamaha website then download the manual file. Since specifications, equipment or separately sold accessories may not be the same in every locale, please check with your Yamaha dealer.

Index

Numerics

50 Classics109

A

AB Repeat 50
AC adaptor 14
Accesspoint Mode 79
Aliquot 27
Aliquot Resonance (Aliquot Res.) 26
App 84
Audio EQ 85
Audio Loop Back 85
Audio Recording 54
Audio Song 44
Auto Power Off 15
Aux Assign 18

B

Backup 105
Backup Setting 105
Bass 43
Binaural Sampling 17
Bluetooth 8, 81
Body Resonance (Body Res.) 26
Brightness 26

C

Chorus 28
Chorus Type List 92
Computer 75, 81
Computer-related Operations 9
Connection 72
Contrast 101
Convert 70
Copy 68

D

Damper pedal 19
Damper Resonance 18
Damper Resonance (Damper Res.) 26
Delete 68
Demo 24
Detailed Settings 88
Display 20
Dual 29, 31
Duo 32

E

Edit (Song) 94
Edit (Voice) 90
Effect 28
Effect Depth 90
Effect Type List 92
Ending 43
EQ (Equalizer) 38

F

Factory Reset 106
Fast forward 47
File Operation 66
Footswitch 18
Format 8
Format (USB flash drive) 101

H

Half Pedal Point 27
Half-pedal 18
Headphones 16

I

IAC 16
Infrastructure Mode 76, 103
Intelligent Acoustic Control (IAC) 16
Intro 43

K

Key Off Sample 26

L

Lid Position 26

M

Manual Setup 78
Master EQ 38, 87
Master EQ type list 38
Master Tune 26, 35
MASTER VOLUME 16
Message List 110
Metronome 41
Metronome/Rhythm Menu 96
MIDI 80, 100
MIDI Recording 54
MIDI Reference 9
MIDI Song 44

MIDI to Audio	70	Sound Boost type list	37
Move	69	Split	30, 31
N		Split Point	30
Network	76	Stage setup	86
O		Stereophonic Optimizer	17
Octave	90	String Resonance (String Res.)	26
P		System Menu	98
Pairing	82	T	
Panel Lock	40, 87	Tempo	41
Part	48	Tempo (Song)	47, 64
Pedal	18, 53, 99	Time signature	42
Pedal Function List	92	Touch	26, 36
Pedal Unit	19	Touch Sensitivity list	36
Piano Room	25	Track	48, 57
Pitch	26, 35	Transpose (Keyboard)	34, 89
Playback (Rhythm)	43	Transpose (Song)	53, 93
Playback (Song)	45	Troubleshooting	112
Power	14	Tuning	35, 98
Power cord	14	U	
Preset Voice List	107	USB Audio Interface	85
R		USB Autoload	101
Random	51	USB flash drive	74
Recording	54	User	45
Recording Menu	97	Utility	101
Rename	71	V	
Repeat	49	Voice	22, 64
Restore	106	Voice Menu	89
Reverb	26, 28	Volume	90
Reverb Type List	92	Volume (Metronome)	96
Rewind	47	Volume Balance	52
Rhythm	43	VRM	26, 27
Rhythm List	109	W	
S		Wireless LAN	76, 103
Scale Tune	98	WPS	77
Scale Tune List	98	X	
Smart Device	75, 81	XG Voice	23
Smart Device Connection Manual	9		
Smart Pianist	84		
Soft pedal	19		
Song	44, 66		
Song List	109		
Song Menu	93		
Song Repeat	51		
Sostenuto pedal	19		
SOUND BOOST	37, 87		

Information for users on collection and disposal of old equipment:



This symbol on the products, packaging, and/or accompanying documents means that used electrical and electronic products should not be mixed with general household waste. For proper treatment, recovery and recycling of old products, please take them to applicable collection points, in accordance with your national legislation.

By disposing of these products correctly, you will help to save valuable resources and prevent any potential negative effects on human health and the environment which could otherwise arise from inappropriate waste handling.

For more information about collection and recycling of old products, please contact your local municipality, your waste disposal service or the point of sale where you purchased the items.

For business users in the European Union:

If you wish to discard electrical and electronic equipment, please contact your dealer or supplier for further information.

Information on Disposal in other Countries outside the European Union:

This symbol is only valid in the European Union. If you wish to discard these items, please contact your local authorities or dealer and ask for the correct method of disposal.

(weee_eu_en_02)

Memo

For U.S.A.

This transmitter must not be co-located or operated in conjunction with any other antenna or transmitter.

For CANADA

This device complies with Industry Canada licence-exempt RSS standard(s). Operation is subject to the following two conditions: (1) this device may not cause interference, and (2) this device must accept any interference, including interference that may cause undesired operation of the device.

Le présent appareil est conforme aux CNR d'Industrie Canada applicables aux appareils radio exempts de licence. L'exploitation est autorisée aux deux conditions suivantes : (1) l'appareil ne doit pas produire de brouillage, et (2) l'utilisateur de l'appareil doit accepter tout brouillage radioélectrique subi, même si le brouillage est susceptible d'en compromettre le fonctionnement.

For U.S.A. and CANADA

This equipment complies with FCC/IC radiation exposure limits set forth for an uncontrolled environment and meets the FCC radio frequency (RF) Exposure Guidelines and RSS-102 of the IC radio frequency (RF) Exposure rules. This equipment has very low levels of RF energy that are deemed to comply without testing of specific absorption rate (SAR).

Cet équipement est conforme aux limites d'exposition aux rayonnements énoncées pour un environnement non contrôlé et respecte les règles des radioélectriques (RF) de la FCC lignes directrices d'exposition et d'exposition aux fréquences radioélectriques (RF) CNR-102 de l'IC. Cet équipement émet une énergie RF très faible qui est considérée conforme sans évaluation du débit d'absorption spécifique (DAS).

For EU countries

BG Bulgarian

ОПРОСТЕНА ЕС ДЕКЛАРАЦИЯ ЗА СЪОТВЕТСТВИЕ

С настоящото Yamaha Music Europe GmbH декларира, че този тип радиосъоръжение [P-515] е в съответствие с Директива 2014/53/ЕС. Цялостният текст на ЕС декларацията за съответствие може да се намери на следния интернет адрес: <https://europe.yamaha.com/en/support/compliance/doc.html>

ES Spanish

DECLARACIÓN UE DE CONFORMIDAD SIMPLIFICADA

Por la presente, Yamaha Music Europe GmbH declara que el tipo de equipo radioeléctrico [P-515] es conforme con la Directiva 2014/53/UE. El texto completo de la declaración UE de conformidad está disponible en la dirección Internet siguiente: <https://europe.yamaha.com/en/support/compliance/doc.html>

CS Czech

ZJEDNODUŠENÉ EU PROHLÁŠENÍ O SHODĚ

Tímto Yamaha Music Europe GmbH prohlašuje, že typ rádiového zařízení [P-515] je v souladu se směrnicí 2014/53/EU. Úplné znění EU prohlášení o shodě je k dispozici na této internetové adrese: <https://europe.yamaha.com/en/support/compliance/doc.html>

DA Danish

FORENKLET EU-OVERENSSTEMMELSESERKLÆRING

Hermed erklærer Yamaha Music Europe GmbH, at radioudstyrstypen [P-515] er i overensstemmelse med direktiv 2014/53/EU. EU-overensstemmelseserklæringens fulde tekst kan findes på følgende internetadresse: <https://europe.yamaha.com/en/support/compliance/doc.html>

DE German

VEREINFACHTE EU-KONFORMITÄTSERKLÄRUNG

Hiermit erklärt Yamaha Music Europe GmbH, dass der Funkanlagentyp [P-515] der Richtlinie 2014/53/EU entspricht. Der vollständige Text der EU-Konformitätserklärung ist unter der folgenden Internetadresse verfügbar: <https://europe.yamaha.com/en/support/compliance/doc.html>

ET Estonian

LIHTSUSTATUD ELI VASTAVUSDEKLARATSIOON

Käesolevaga deklareerib Yamaha Music Europe GmbH, et käesolev raadioseadme tüüp [P-515] vastab direktiivi 2014/53/EL nõuetele. ELi vastavusdeklaratsiooni täielik tekst on kättesaadav järgmisel internetiaadressil: <https://europe.yamaha.com/en/support/compliance/doc.html>

EL Greek

ΑΠΛΟΥΣΤΕΥΜΕΝΗ ΔΗΛΩΣΗ ΣΥΜΜΟΡΦΩΣΗΣ ΕΕ

Με την παρούσα ο/η Yamaha Music Europe GmbH, δηλώνει ότι ο ραδιοεξοπλισμός [P-515] πληροί την οδηγία 2014/53/ΕΕ. Το πλήρες κείμενο της δήλωσης συμμόρφωσης ΕΕ διατίθεται στην ακόλουθη ιστοσελίδα στο διαδίκτυο: <https://europe.yamaha.com/en/support/compliance/doc.html>

EN English

SIMPLIFIED EU DECLARATION OF CONFORMITY

Hereby, Yamaha Music Europe GmbH declares that the radio equipment type [P-515] is in compliance with Directive 2014/53/EU. The full text of the EU declaration of conformity is available at the following internet address: <https://europe.yamaha.com/en/support/compliance/doc.html>

FR French

DECLARATION UE DE CONFORMITE SIMPLIFIEE

Le soussigné, Yamaha Music Europe GmbH, déclare que l'équipement radioélectrique du type [P-515] est conforme à la directive 2014/53/UE. Le texte complet de la déclaration UE de conformité est disponible à l'adresse internet suivante: <https://europe.yamaha.com/en/support/compliance/doc.html>

HR Croatian

POJEDNOSTAVLJENA EU IZJAVA O SUKLADNOSTI

Yamaha Music Europe GmbH ovime izjavljuje da je radijska oprema tipa [P-515] u skladu s Direktivom 2014/53/EU. Cjeloviti tekst EU izjave o sukladnosti dostupan je na sljedećoj internetskoj adresi: <https://europe.yamaha.com/en/support/compliance/doc.html>

IT Italian

DICHIARAZIONE DI CONFORMITÀ UE SEMPLIFICATA

Il fabbricante, Yamaha Music Europe GmbH, dichiara che il tipo di apparecchiatura radio [P-515] è conforme alla direttiva 2014/53/UE. Il testo completo della dichiarazione di conformità UE è disponibile al seguente indirizzo Internet: <https://europe.yamaha.com/en/support/compliance/doc.html>

LV Latvian

VIENTĀRSŪTA ES ATBILSTĪBAS DEKLARĀCIJA

Ar šo Yamaha Music Europe GmbH deklarē, ka radioiekārta [P-515] atbilst Direktīvai 2014/53/ES. Pilns ES atbilstības deklarācijas teksts ir pieejams šādā interneta vietnē: <https://europe.yamaha.com/en/support/compliance/doc.html>

LT Lithuanian

SUPAPRASTINTA ES ATITIKTIES DEKLARACIJA

Aš, Yamaha Music Europe GmbH, patvirtinu, kad radijo įrenginių tipas [P-515] atitinka Direktyvą 2014/53/ES. Visas ES atitikties deklaracijos tekstas prieinamas šiuo interneto adresu: <https://europe.yamaha.com/en/support/compliance/doc.html>

HU Hungarian

EGYSZERŰSÍTETT EU-MEGFELELŐSÉGI NYILATKOZAT

Yamaha Music Europe GmbH igazolja, hogy a [P-515] típusú rádióberendezés megfelel a 2014/53/EU irányelvnek. Az EU-megfelelőségi nyilatkozat teljes szövege elérhető a következő internetes címen: <https://europe.yamaha.com/en/support/compliance/doc.html>

NL Dutch

VEREENVOUDIGDE EU-CONFORMITEITSVERKLARING

Hierbij verklaar ik, Yamaha Music Europe GmbH, dat het type radioapparatuur [P-515] conform is met Richtlijn 2014/53/EU. De volledige tekst van de EU-conformiteitsverklaring kan worden geraadpleegd op het volgende internetadres: <https://europe.yamaha.com/en/support/compliance/doc.html>

PL Polish

UPROSZCZONA DEKLARACJA ZGODNOŚCI UE

Yamaha Music Europe GmbH niniejszym oświadcza, że typ urządzenia radiowego [P-515] jest zgodny z dyrektywą 2014/53/UE. Pełny tekst deklaracji zgodności UE jest dostępny pod następującym adresem internetowym: <https://europe.yamaha.com/en/support/compliance/doc.html>

PT Portuguese

DECLARAÇÃO UE DE CONFORMIDADE SIMPLIFICADA

O(a) abaixo assinado(a) Yamaha Music Europe GmbH declara que o presente tipo de equipamento de rádio [P-515] está em conformidade com a Diretiva 2014/53/UE. O texto integral da declaração de conformidade está disponível no seguinte endereço de Internet: <https://europe.yamaha.com/en/support/compliance/doc.html>

RO Romanian

DECLARAȚIA UE DE CONFORMITATE SIMPLIFICATĂ

Prin prezenta, Yamaha Music Europe GmbH declară că tipul de echipamente radio [P-515] este în conformitate cu Directiva 2014/53/UE. Textul integral al declarației UE de conformitate este disponibil la următoarea adresă internet: <https://europe.yamaha.com/en/support/compliance/doc.html>

SK Slovak

ZJEDNODUŠENÉ EÚ VYHLÁSENIE O ZHODE

Yamaha Music Europe GmbH týmto vyhlasuje, že rádiové zariadenie typu [P-515] je v súlade so smernicou 2014/53/EU. Úplné EÚ vyhlásenie o zhode je k dispozícii na tejto internetovej adrese: <https://europe.yamaha.com/en/support/compliance/doc.html>

SL Slovenian

POENOSTAVLJENA IZJAVA EU O SKLADNOSTI

Yamaha Music Europe GmbH potrjuje, da je tip radijske opreme [P-515] skladen z Direktivo 2014/53/EU. Celotno besedilo izjave EU o skladnosti je na voljo na naslednjem spletnem naslovu: <https://europe.yamaha.com/en/support/compliance/doc.html>

FI Finnish

YKSINKERTAISTETTU EU-VAATIMUSTENMUKAISUUSVAKUUTUS

Yamaha Music Europe GmbH vakuuttaa, että radiolaitetyypin [P-515] on direktiivin 2014/53/EU mukainen. EU-vaatimustenmukaisuusvakuutuksen täysimittainen teksti on saatavilla seuraavassa internetosoitteessa: <https://europe.yamaha.com/en/support/compliance/doc.html>

SV Swedish

FÖRENKLAD EU-FÖRSÄKRAN OM ÖVERENSSTÄMMELSE

Härmed försäkras Yamaha Music Europe GmbH att denna typ av radioutrustning [P-515] överensstämmer med direktiv 2014/53/EU. Den fullständiga texten till EU-försäkran om överensstämmelse finns på följande webbadress: <https://europe.yamaha.com/en/support/compliance/doc.html>

TR Turkey

BASİTEŞTİRİLMİŞ AVRUPA BİRLİĞİ UYGUNLUK BİLDİRİMİ

İşbu belge ile, Yamaha Music Europe GmbH, radyo cihaz tipinin [P-515], Direktif 2014/53/AB'ye uygunluğunu beyan eder. AB uyumu beyanının tam metni aşağıdaki internet adresinden edinilebilir: <https://europe.yamaha.com/en/support/compliance/doc.html>

Important Notice: Guarantee Information for customers in European Economic Area (EEA) and Switzerland

<p>Important Notice: Guarantee Information for customers in EEA* and Switzerland</p> <p>For detailed guarantee information about this Yamaha product, and Pan-EEA* and Switzerland warranty service, please either visit the website address below (Printable file is available at our website) or contact the Yamaha representative office for your country. * EEA: European Economic Area</p>	English
<p>Wichtiger Hinweis: Garantie-Information für Kunden in der EWR* und der Schweiz</p> <p>Für nähere Garantie-Information über dieses Produkt von Yamaha, sowie über den Pan-EWR*- und Schweizer Garantieservice, besuchen Sie bitte entweder die folgend angegebene Internetadresse (eine druckfähige Version befindet sich auch auf unserer Webseite), oder wenden Sie sich an den für Ihr Land zuständigen Yamaha-Vertrieb. *EWR: Europäischer Wirtschaftsraum</p>	Deutsch
<p>Remarque importante: informations de garantie pour les clients de l'EEE et la Suisse</p> <p>Pour des informations plus détaillées sur la garantie de ce produit Yamaha et sur le service de garantie applicable dans l'ensemble de l'EEE ainsi qu'en Suisse, consultez notre site Web à l'adresse ci-dessous (le fichier imprimable est disponible sur notre site Web) ou contactez directement Yamaha dans votre pays de résidence. * EEE : Espace Economique Européen</p>	Français
<p>Belangrijke mededeling: Garantie-informatie voor klanten in de EER* en Zwitserland</p> <p>Voor gedetailleerde garantie-informatie over dit Yamaha-product en de garantieservice in heel de EER* en Zwitserland, gaat u naar de onderstaande website (u vindt een afdrukbaar bestand op onze website) of neemt u contact op met de vertegenwoordiging van Yamaha in uw land. * EER: Europese Economische Ruimte</p>	Nederlands
<p>Aviso importante: información sobre la garantía para los clientes del EEE* y Suiza</p> <p>Para una información detallada sobre este producto Yamaha y sobre el soporte de garantía en la zona EEE* y Suiza, visite la dirección web que se incluye más abajo (la versión del archivo para imprimir esta disponible en nuestro sitio web) o póngase en contacto con el representante de Yamaha en su país. * EEE: Espacio Económico Europeo</p>	Español
<p>Avviso importante: informazioni sulla garanzia per i clienti residenti nell'EEA* e in Svizzera</p> <p>Per informazioni dettagliate sulla garanzia relativa a questo prodotto Yamaha e l'assistenza in garanzia in garanzia nei paesi EEA* e in Svizzera, potete consultare il sito Web all'indirizzo riportato di seguito (è disponibile il file in formato stampabile) oppure contattare l'ufficio di rappresentanza locale della Yamaha. * EEA: Area Economica Europea</p>	Italiano
<p>Aviso importante: informações sobre as garantias para clientes da AEE* e da Suíça</p> <p>Para obter uma informação pormenorizada sobre este produto da Yamaha e sobre o serviço de garantia na AEE* e na Suíça, visite o site a seguir (o arquivo para impressão está disponível no nosso site) ou entre em contato com o escritório de representação da Yamaha no seu país. * AEE: Área Económica Europeia</p>	Português
<p>Σημαντική σημείωση: Πληροφορίες εγγύησης για τους πελάτες στον ΕΟΧ* και Ελλάδα</p> <p>Για λεπτομερείς πληροφορίες εγγύησης σχετικά με το παρόν προϊόν της Yamaha και την κάλυψη εγγύησης σε όλες τις χώρες του ΕΟΧ και την Ελλάδα, επισκεφτείτε την παρακάτω ιστοσελίδα (Εκτυπωσιμη μορφή είναι διαθέσιμη στην ιστοσελίδα μας) ή απευθυνθείτε στην αντιπροσωπεία της Yamaha στη χώρα σας. * ΕΟΧ: Ευρωπαϊκός Οικονομικός Χώρος</p>	Ελληνικά
<p>Viktigt: Garantiinformation för kunder i EES-området* och Schweiz</p> <p>För detaljerad information om denna Yamaha-produkt samt garantiservice i hela EES-området* och Schweiz kan du antingen besöka nedanstående webbadress (en utskriftsvänlig fil finns på webbplatsen) eller kontakta Yamahas officiella representant i ditt land. * EES: Europeiska Ekonomiska Samarbetsområdet</p>	Svenska
<p>Viktig merknad: Garantiinformasjon for kunder i EØS* og Sveits</p> <p>Detaljert garantiinformasjon om dette Yamaha-produktet og garantiservice for hele EØS-området* og Sveits kan fås enten ved å besøke nettadressen nedenfor (utskriftsversjon finnes på våre nettsider) eller kontakte Yamahas kontoret i landet der du bor. *EØS: Det europeiske økonomiske samarbeidsområdet</p>	Norsk
<p>Vigtig oplysning: Garantioplysninger til kunder i EØO* og Schweiz</p> <p>De kan finde detaljerede garantioplysninger om dette Yamaha-produkt og den fælles garantiserviceordning for EØO* (og Schweiz) ved at besøge det websted, der er angivet nedenfor (der findes en fil, som kan udskrives, på vores websted), eller ved at kontakte Yamahas nationale repræsentationskontor i det land, hvor De bor. * EØO: Det Europæiske Økonomiske Område</p>	Dansk
<p>Tärkeä ilmoitus: Takuutiedot Euroopan talousalueen (ETA) ja Sveitsin asiakkaille</p> <p>Tämän Yamaha-tuotteen sekä ETA-alueen ja Sveitsin takuuta koskevat yksityiskohtaiset tiedot saatte alla olevasta nettiosoitteesta. (Tulostettava tiedosto saatavissa sivustollamme.) Voitte myös ottaa yhteyttä paikalliseen Yamaha-edustajaan. *ETA: Euroopan talousalue</p>	Suomi
<p>Ważne: Warunki gwarancyjne obowiązujące w EOG* i Szwajcarii</p> <p>Aby dowiedzieć się więcej na temat warunków gwarancyjnych tego produktu firmy Yamaha i serwisu gwarancyjnego w całym EOG* i Szwajcarii, należy odwiedzić wskazaną poniżej stronę internetową (Plik gotowy do wydruku znajduje się na naszej stronie internetowej) lub skontaktować się z przedstawicielstwem firmy Yamaha w swoim kraju. * EOG — Europejski Obszar Gospodarczy</p>	Polski
<p>Důležité oznámení: Záruční informace pro zákazníky v EHS* a ve Švýcarsku</p> <p>Podrobné záruční informace o tomto produktu Yamaha a záručním servisu v celém EHS* a ve Švýcarsku naleznete na níže uvedeném webovém adresě (soubor k tisku je dostupný na našich webových stránkách) nebo se můžete obrátit na zastoupení firmy Yamaha ve své zemi. * EHS: Evropský hospodářský prostor</p>	Česky
<p>Fontos figyelmeztetés: Garancia-információk az EGT* területén és Svájcban élő vásárlók számára</p> <p>A jelen Yamaha termékre vonatkozó részletes garancia-információk, valamint az EGT*-re és Svájcra kiterjedő garanciális szolgáltatás tekintetében keresse fel webhelyünket az alábbi címen (a webhelyen nyomtatható fájl is talál), vagy pedig lépjen kapcsolatba az országában működő Yamaha képviselői irodával. * EGT: Európai Gazdasági Térség</p>	Magyar
<p>Oluline märkus: Garantiiteave Euroopa Majanduspiirkonna (EMP)* ja Šveitsi klientidele</p> <p>Täpsema teabe saamiseks selle Yamaha toote garantii ning kogu Euroopa Majanduspiirkonna ja Šveitsi garantiiteeniduse kohta, külastage palun veebisaiti alljärgneval aadressil (meie saidil on saadaval printitav fail) või pöörduge Teie regiooni Yamaha esinduse poole. * EMP: Euroopa Majanduspiirkond</p>	Eesti keel
<p>Svarīgs paziņojums: garantijas informācija klientiem EEZ* un Šveicē</p> <p>Lai saņemtu detalizētu garantijas informāciju par šo Yamaha produktu, kā arī garantijas apkalpošanu EEZ* un Šveicē, lūdzam apmeklējiet zemāk norādīto tīmekļa vietnes adresi (tīmekļa vietnē ir pieejams drukājams fails) vai sazinieties ar jūsu valsti apkalpojošo Yamaha pārstāvniecību. * EEZ: Eiropas Ekonomikas zona</p>	Latviešu
<p>Dėmesio: informacija dėl garantijos pirkėjams EEE* ir Šveicarijoje</p> <p>Jei reikia išsamios informacijos apie šį „Yamaha“ produktą ir jo techninę priežiūrą visoje EEE* ir Šveicarijoje, apsilankykite mūsų svetainėje toliau nurodytu adresu (svetainėje yra spausdinamas failas) arba kreipkitės į „Yamaha“ atstovybę savo šaliai. *EEE – Europos ekonominė erdvė</p>	Lietuvių kalba
<p>Dôležité upozornenie: Informácie o záruke pre zákazníkov v EHP* a Švajčiarsku</p> <p>Podrobné informácie o záruke týkajúce sa tohto produktu od spoločnosti Yamaha a garančnom servise v EHP* a Švajčiarsku nájdete na webovej stránke uvedenej nižšie (na našej webovej stránke je k dispozícii súbor na tlač) alebo sa obráťte na zástupcu spoločnosti Yamaha vo svojej krajine. * EHP: Európsky hospodársky priestor</p>	Slovenčina
<p>Pomembno obvestilo: Informacije o garanciji za kupce v EGP* in Švici</p> <p>Za podrobnejše informacije o tem Yamahinem izdelku ter garancijskem servisu v celotnem EGP in Švici, obiščite spletno mesto, ki je navedeno spodaj (natisljiva datoteka je na voljo na našem spletnem mestu), ali se obrnite na Yamahinega predstavnika v svoji državi. * EGP: Evropski gospodarski prostor</p>	Slovenščina
<p>Важно съобщение: Информация за гаранцията за клиенти в ЕИП* и Швейцария</p> <p>За подробна информация за гаранцията за този продукт на Yamaha и гаранционното обслужване в паневропейската зона на ЕИП* и Швейцария или посетете посочения по-долу уеб сайт (на нашия уеб сайт има файл за печат), или се свържете с представителния офис на Yamaha във вашата страна. * ЕИП: Европейско икономическо пространство</p>	Български език
<p>Notificare importantă: Informații despre garanție pentru clienții din SEE* și Elveția</p> <p>Pentru informații detaliate privind acest produs Yamaha și serviciul de garanție Pan-SEE* și Elveția, vizitați site-ul la adresa de mai jos (fișierul imprimabil este disponibil pe site-ul nostru) sau contactați biroul reprezentanței Yamaha din țara dumneavoastră. * SEE: Spațiul Economic European</p>	Limba română

<http://europe.yamaha.com/warranty/>

For details of products, please contact your nearest Yamaha representative or the authorized distributor listed below.

Para detalles sobre productos, contacte su tienda Yamaha más cercana o el distribuidor autorizado que se lista debajo.

Pour plus de détails sur les produits, veuillez-vous adresser à Yamaha ou au distributeur le plus proche de vous figurant dans la liste suivante.

NORTH AMERICA

CANADA

Yamaha Canada Music Ltd.
135 Milner Avenue, Toronto, Ontario M1S 3R1,
Canada
Tel: +1-416-298-1311

U.S.A.

Yamaha Corporation of America
6600 Orangethorpe Avenue, Buena Park, CA 90620,
U.S.A.
Tel: +1-714-522-9011

CENTRAL & SOUTH AMERICA

MEXICO

Yamaha de México, S.A. de C.V.
Av. Insurgentes Sur 1647 Piso 9, Col. San José
Insurgentes, Delegación Benito Juárez, México,
D.F., C.P. 03900, México
Tel: +52-55-5804-0600

BRAZIL

Yamaha Musical do Brasil Ltda.
Rua Fidêncio Ramos, 302 – Cj 52 e 54 – Torre B –
Vila Olímpia – CEP 04551-010 – São Paulo/SP,
Brazil
Tel: +55-11-3704-1377

ARGENTINA

**Yamaha Music Latin America, S.A.,
Sucursal Argentina**
Olga Cossetini 1553, Piso 4 Norte,
Madero Este-C1107CEK,
Buenos Aires, Argentina
Tel: +54-11-4119-7000

PANAMA AND OTHER LATIN

AMERICAN COUNTRIES/ CARIBBEAN COUNTRIES

Yamaha Music Latin America, S.A.
Edif. Torre Banco General, F7, Urb. Marbella,
Calle 47 y Aquilino de la Guardia, Panama,
P.O.Box 0823-05863, Panama, Rep. de Panama
Tel: +507-269-5311

EUROPE

THE UNITED KINGDOM/IRELAND

Yamaha Music Europe GmbH (UK)
Sherbourne Drive, Tilbrook, Milton Keynes,
MK7 8BL, U.K.
Tel: +44-1908-366700

GERMANY

Yamaha Music Europe GmbH
Siemensstrasse 22-34, 25462 Rellingen, Germany
Tel: +49-4101-303-0

SWITZERLAND/LIECHTENSTEIN

**Yamaha Music Europe GmbH, Branch
Switzerland in Thalwil**
Seestrasse 18a, 8800 Thalwil, Switzerland
Tel: +41-44-3878080

AUSTRIA/CROATIA/CZECH REPUBLIC/ HUNGARY/ROMANIA/SLOVAKIA/ SLOVENIA

Yamaha Music Europe GmbH, Branch Austria
Schleiergasse 20, 1100 Wien, Austria
Tel: +43-1-60203900

POLAND

**Yamaha Music Europe GmbH
Sp.z o.o. Oddział w Polsce**
ul. Wielicka 52, 02-657 Warszawa, Poland
Tel: +48-22-380-08-88

BULGARIA

Dinacord Bulgaria LTD.
Bul. Iskarsko Schose 7 Targowski Zentar Ewropa
1528 Sofia, Bulgaria
Tel: +359-2-978-20-25

MALTA

Olimpus Music Ltd.
Valletta Road, Mosta MST9010, Malta
Tel: +356-2133-2093

NETHERLANDS/BELGIUM/ LUXEMBOURG

Yamaha Music Europe, Branch Benelux
Clarissenhof 5b, 4133 AB Vianen, The Netherlands
Tel: +31-347-358040

FRANCE

Yamaha Music Europe
7 rue Ambroise Croizat, Zone d'activités de Pariest,
77183 Croissy-Beaubourg, France
Tel: +33-1-6461-4000

ITALY

Yamaha Music Europe GmbH, Branch Italy
Via Tinelli N.67/69 20855 Gerno di Lesmo (MB),
Italy
Tel: +39-039-9065-1

SPAIN/PORTUGAL

**Yamaha Music Europe GmbH Ibérica, Sucursal
en España**
Ctra. de la Coruña km. 17,200, 28231
Las Rozas de Madrid, Spain
Tel: +34-91-639-88-88

GREECE

Philippos Nakas S.A. The Music House
19th km. Leof. Lavriou 190 02 Peania – Attiki,
Greece
Tel: +30-210-6686260

SWEDEN

**Yamaha Music Europe GmbH Germany filial
Scandinavia**
JA Wettergrensgata 1, 400 43 Göteborg, Sweden
Tel: +46-31-89-34-00

DENMARK

**Yamaha Music Denmark,
Fillial of Yamaha Music Europe GmbH, Tyskland**
Generatorvej 8C, ST. TH., 2860 Søborg, Denmark
Tel: +45-44-92-49-00

FINLAND

F-Musiikki Oy
Antaksentie 4
FI-01510 Vantaa, Finland
Tel: +358 (0)96185111

NORWAY

**Yamaha Music Europe GmbH Germany -
Norwegian Branch**
Grini Næringspark 1, 1332 Østerås, Norway
Tel: +47-6716-7800

ICELAND

Hljóðfaerhusid Ehf.
Sidumula 20
IS-108 Reykjavik, Iceland
Tel: +354-525-5050

CYPRUS

Nakas Music Cyprus Ltd.
Nikis Ave 2k
1086 Nicosia
Tel: + 357-22-511080
Major Music Center
21 Ali Riza Ave. Ortakoy
P.O.Box 475 Lefkoşa, Cyprus
Tel: (392) 227 9213

RUSSIA

Yamaha Music (Russia) LLC.
Room 37, entrance 7, bld. 7, Kievskaya street,
Moscow, 121059, Russia
Tel: +7-495-626-5005

OTHER EUROPEAN COUNTRIES

Yamaha Music Europe GmbH
Siemensstrasse 22-34, 25462 Rellingen, Germany
Tel: +49-4101-303-0

AFRICA

Yamaha Music Gulf FZE
JAFZA-16, Office 512, P.O.Box 17328,
Jebel Ali FZE, Dubai, UAE
Tel: +971-4-801-1500

MIDDLE EAST

TURKEY

**Yamaha Music Europe GmbH
Merkezi Almany Türkiye Istanbul Şubesi**
Mor Sumbul Sokak Varyap Meridian Business
1.Blok No:1 113-114-115
Bati Atasehir Istanbul, Turkey
Tel: +90-216-275-7960

ISRAEL

RBX International Co., Ltd.
P.O.Box 10245, Petach-Tikva, 49002
Tel: (972) 3-925-6900

OTHER COUNTRIES

Yamaha Music Gulf FZE
JAFZA-16, Office 512, P.O.Box 17328,
Jebel Ali FZE, Dubai, UAE
Tel: +971-4-801-1500

ASIA

THE PEOPLE'S REPUBLIC OF CHINA

Yamaha Music & Electronics (China) Co., Ltd.
2F, Yunhedasha, 1818 Xinzha-lu, Jingan-qu,
Shanghai, China
Tel: +86-400-051-7700

HONG KONG

Tom Lee Music Co., Ltd.
11/F., Silvercord Tower 1, 30 Canton Road,
Tsimshatsui, Kowloon, Hong Kong
Tel: +852-2737-7688

INDIA

Yamaha Music India Private Limited
P-401, JMD Megapolis, Sector-48, Sohna Road,
Gurgaon-122018, Haryana, India
Tel: +91-124-485-3300

INDONESIA

PT. Yamaha Musik Indonesia (Distributor)
Yamaha Music Center Bldg. Jalan Jend. Gatot
Subroto Kav. 4, Jakarta 12930, Indonesia
Tel: +62-21-520-2577

KOREA

Yamaha Music Korea Ltd.
11F, Prudential Tower, 298, Gangnam-daero,
Gangnam-gu, Seoul, 06253, Korea
Tel: +82-2-3467-3300

MALAYSIA

Yamaha Music (Malaysia) Sdn. Bhd.
No.8, Jalan Perbandaran, Kelana Jaya, 47301
Petaling Jaya, Selangor, Malaysia
Tel: +60-3-78030900

SINGAPORE

Yamaha Music (Asia) Private Limited
Block 202 Hougang Street 21, #02-00,
Singapore 530202, Singapore
Tel: +65-6740-9200

TAIWAN

Yamaha Music & Electronics Taiwan Co., Ltd.
2F., No.1, Yuandong Rd., Banqiao Dist.,
New Taipei City 22063, Taiwan (R.O.C.)
Tel: +886-2-7741-8888

THAILAND

Siam Music Yamaha Co., Ltd.
3, 4, 15, 16th Fl., Siam Motors Building,
891/1 Rama 1 Road, Wangmai,
Pathumwan, Bangkok 10330, Thailand
Tel: +66-2215-2622

VIETNAM

Yamaha Music Vietnam Company Limited
15th Floor, Nam A Bank Tower, 201-203 Cach
Mang Thang Tam St., Ward 4, Dist.3,
Ho Chi Minh City, Vietnam
Tel: +84-28-3818-1122

OTHER ASIAN COUNTRIES

[https://asia-latinamerica-mea.yamaha.com/
index.html](https://asia-latinamerica-mea.yamaha.com/index.html)

OCEANIA

AUSTRALIA

Yamaha Music Australia Pty. Ltd.
Level 1, 80 Market Street, South Melbourne,
VIC 3205 Australia
Tel: +61-3-9693-5111

NEW ZEALAND

Music Works LTD
P.O.BOX 6246 Wellesley, Auckland 4680,
New Zealand
Tel: +64-9-634-0099

COUNTRIES AND TRUST TERRITORIES IN PACIFIC OCEAN

[https://asia-latinamerica-mea.yamaha.com/
index.html](https://asia-latinamerica-mea.yamaha.com/index.html)

Yamaha Global Site
<https://www.yamaha.com/>
Yamaha Downloads
<https://download.yamaha.com/>

Manual Development Group
© 2018 Yamaha Corporation
Published 11/2018 POMA*. *- **B0

VAA7850